



**Touran II**

**09/15 →**

<b>D</b>	Elektro-Einbausatz für Anhängerkupplung / 13-polig / 12 Volt / ISO 11446
<b>GB</b>	Fitting instructions Electric wiring kit for towbars / 13-pin / 12 Volt / ISO 11446
<b>F</b>	Instructions de montage Faisceau pour attelage / 13 broches / 12 Volt / ISO 11446
<b>I</b>	Istruzione di montaggio Cablaggio elettrico per ganci di traino / 13 poli / 12 Volt / ISO 11446
<b>E</b>	Instrucciones de montaje Kits eléctricos para enganches de remolques / 13 pins / 12 Volt / ISO 11446
<b>NL</b>	Montagehandleiding Elektro-inbouwset voor aanhangerkoppeling / 13-polig / 12 Volt / ISO 11446

**Aktuellste Version:**  
Latest version:





## WICHTIG!

**D**

### Vor Montagebeginn:

- Die aktuellen Herstellervorgaben beachten!
- Die Einbauanleitung komplett durchlesen und zwingend beachten!
- Dieses Produkt ist nur für linksgelenkte (LHD) Fahrzeuge geeignet!
- Bei Fremdverwendung oder Veränderung des Produktes erlischt jeglicher Anspruch auf Einbauunterstützung und Gewährleistung!

Änderungen bezüglich Konstruktion, Ausstattung, Farbe sowie Irrtum vorbehalten. Alle Angaben und Abbildungen sind unverbindlich. Der in Deutsch gehaltene Text in dieser Einbau-Anleitung ist bindend!

Für technische bzw. elektronische Änderungen, sowie Softwareupdates, welche nach erstmaliger Inbetriebnahme des Elektrosatzes vom Fahrzeughersteller durchgeführt werden und beispielsweise zu Fehlfunktionen der Anhängersteckdose oder deren Peripherie führen, übernehmen wir keinerlei Gewährleistung!

Je nach Art des im E-Satz verwendeten Anhängermoduls ist eine Interaktion mit dem Fahrzeugbordnetz nur eingeschränkt oder gar nicht möglich. Mit den spezifischen Diagnosesystemen der Fahrzeughersteller kann nicht auf modulinterne Fehlerspeicher zugegriffen werden.

Fehlerprotokolle in Bezug auf Anhängerbetrieb, die während eines Prüfprozesses mit den Diagnosesystemen der Fahrzeughersteller generiert werden, sind mitunter auf eine nicht ordnungsgemäße Freischaltung für Anhängerbetrieb zurückzuführen.

### Wir empfehlen

- die Auswertung der fahrzeugseitigen Fehlerspeicher sowie ggf. die Instandsetzung aller gelisteten Defekte vor Beginn aller Montagearbeiten!
- das Anhängermodul ggf. vom Leitungssatz zu trennen und den Diagnoseprozess noch einmal zu starten!
- die Fehlersuche bei Funktionsproblemen auf max. 0,5 Stunden zu begrenzen und sich danach an unsere Hotline zu wenden!



**HOTLINE +49 5246 921019**  
support@jaeger-automotive.de



## IMPORTANT!

**GB**

### Before starting the installation:

- Pay attention to the latest manufacturer's specifications!
- Read the complete installation instructions and follow these at all costs!
- This product is only designed for left-hand drive (LHD) vehicles!
- If the product is used for a different purpose or modified, any entitlement to support during the installation and the warranty will be forfeited!

Subject to changes with respect to design, equipment, colour and error. All of the data and illustrations are without obligation. The German text in these installation instructions is binding!

We can assume no warranty or guarantee for technical and electrical modifications or software updates carried out by the vehicle manufacturer following the initial commissioning of the electric kit and which, for example, may lead to malfunctions in the trailer socket or its peripheral equipment!

Depending on the type of trailer module used in the electric kit, interaction with the vehicle's electrical system may be limited or even impossible. The error memory inside the module cannot be accessed with the specific diagnostic system of the vehicle manufacturer.

Error logs relating to the trailer mode that are generated during a test process with the vehicle manufacturer's diagnostic system are sometimes due to an incorrect activation for the trailer mode.

### We recommend

- an analysis of the vehicle's error memory and possibly the repair of all listed faults before the start of the installation!
- possibly disconnecting the trailer module from the lead set and re-starting the diagnosis process!
- limiting troubleshooting in the event of malfunctions to a max. of 0.5 hours and then contacting our hotline!



**HOTLINE +49 5246 921019**  
support@jaeger-automotive.de



## IMPORTANT!

**F**

### Avant de commencer le montage:

- Respecter les consignes actuelles du constructeur!
- Lire la notice d'installation en entier et en tenir rigoureusement compte!
- Ce produit convient uniquement pour les véhicules avec conduite à gauche (LHD)!
- Tout autre usage ou modification du produit entraîne l'annulation de toute prétention à une assistance pour le montage ainsi qu'à la garantie!

Sous réserve de modifications sur le plan de la construction, de l'équipement, de la couleur ainsi que d'erreurs. Toutes les informations et illustrations sont fournies sans engagement. Le texte en allemand dans cette notice d'installation fait foi!

Nous déclinons toute responsabilité pour les modifications techniques ou électroniques, ainsi que pour les mises à jour logicielles réalisées après la mise en service initiale du kit électronique du constructeur du véhicule et pouvant provoquer par exemple des dysfonctionnements de la prise de courant de la remorque ou de sa périphérie!

Suivant le type de module de remorque utilisé dans le kit électronique, une interaction avec le réseau de bord du véhicule n'est pas possible ou ne l'est que dans certaines limites. Il est impossible d'accéder aux mémoires d'erreurs internes avec les systèmes de diagnostic spécifiques des constructeurs de véhicules.

Les procès-verbaux d'erreurs concernant le fonctionnement de la remorque qui ont été générés durant un processus de contrôle avec les systèmes de diagnostic des constructeurs de véhicules sont parfois attribuables à une activation non conforme pour le fonctionnement de la remorque.

### Nous recommandons

- d'analyser les mémoires d'erreurs du véhicule ainsi qu'éventuellement de réparer toutes les défaillances mentionnées avant le commencement de tous les travaux de montage!
- de séparer le module remorque le cas échéant du jeu de câbles et de remettre en marche encore une fois le processus de diagnostic!
- de limiter la recherche d'erreurs à 0,5 h maximum en cas de problèmes de fonctionnement et de s'adresser ensuite à notre hotline!



**HOTLINE +49 5246 921019**  
support@jaeger-automotive.de



## IMPORTANTE!



### Prima dell'inizio del montaggio:

- Si prega di osservare tassativamente le indicazioni attuali del costruttore!
- Leggere integralmente e attenersi alle istruzioni di montaggio!
- Questo prodotto è adatto solo a veicoli con la guida a sinistra (LHD)!
- In caso di utilizzo scorretto o modifica del prodotto, decade ogni diritto di supporto al montaggio e di garanzia!

Con riserva di modifiche strutturali, di dotazione, colore ed errori. Tutti i dati e le figure non sono vincolanti. Il testo in tedesco in queste istruzioni di montaggio è vincolante!

Non concediamo alcuna garanzia per modifiche tecniche o elettroniche, aggiornamenti software che dopo la prima messa in funzione del gruppo elettronico vengono effettuate dal costruttore del veicolo e, ad esempio, possono causare malfunzionamenti della presa del rimorchio o delle sue periferiche!

A seconda del tipo di modulo rimorchio utilizzato nel gruppo elettronico, l'interazione con la rete di bordo del veicolo è possibile solo parzialmente o non è affatto possibile. Con i sistemi di diagnosi specifici dei costruttori di veicoli, non è possibile accedere alla memoria errori interna al modulo.

I protocolli di errore riferiti al funzionamento con rimorchio, generati durante un processo di collaudo con i sistemi di diagnosi dei costruttori di veicoli, sono da ricondurre, tra l'altro, a un'attivazione non corretta per funzionamento con rimorchio.

### Consigliamo

- di effettuare assolutamente l'analisi della memoria errori sul veicolo ed eventualmente la riparazione di tutti i difetti riscontrati, prima di iniziare qualsiasi lavoro di montaggio;
- di scollegare eventualmente il modulo rimorchio dalla serie di cavi e di avviare nuovamente il processo di diagnosi;
- di limitare la ricerca errori in caso di problemi di funzionamento a max. 0,5 ore, quindi di rivolgersi al nostro numero verde.



**HOTLINE** +49 5246 921019  
support@jaeger-automotive.de



## ¡IMPORTANTE!



### Antes de comenzar el montaje:

- ¡Observar las especificaciones actuales del fabricante!
- ¡Leer las instrucciones de montaje por completo y seguir las sin falta!
- ¡Este producto solo es apto para vehículos con volante a la izquierda (LHD)!
- ¡El uso fuera de este ámbito o la modificación del producto supone la extinción de cualquier derecho de asistencia técnica para el montaje y garantía!

Queda reservado el derecho a realizar modificaciones constructivas, de equipamiento y color y de posibles errores. Todos los datos e ilustraciones se entienden sin compromiso. ¡La versión vinculante de estas instrucciones de montaje es la original en lengua alemana!

¡No asumiremos garantía alguna por modificaciones técnicas y/o electrónicas o actualizaciones de software que se lleven a cabo después de la primera puesta en servicio del kit eléctrico por parte del fabricante del vehículo y que puedan dar lugar, por ejemplo, a fallos de funcionamiento de la base eléctrica para el remolque o los periféricos!

En función del tipo de módulo para remolques CFC utilizado en el kit eléctrico no se podrá interactuar con el sistema eléctrico de a bordo o solo de forma limitada. Los sistemas de diagnóstico específicos de los fabricantes de vehículos no permiten el acceso a las memorias de fallos internas del módulo.

Los protocolos de fallos referidos al servicio con remolque, que se generen con sistemas de diagnóstico de los fabricantes de vehículos durante un proceso de inspección, a veces son el resultado de un desbloqueo incorrecto para el servicio con remolque.

### Recomendamos:

- ¡evaluar las memorias de fallos del vehículo y eliminar, en caso dado, todos los defectos enumerados antes de comenzar los trabajos de montaje!
- ¡separar el módulo para remolques del juego de cables en caso dado y volver a iniciar el proceso de diagnóstico!
- ¡limitar la búsqueda de fallos en caso de problemas de funcionamiento a un máximo de 0,5 horas y acudir entonces a nuestra línea de atención!



**HOTLINE** +49 5246 921019  
support@jaeger-automotive.de



## BELANGRIJK!



### Voordat u begint te monteren:

- Raadpleeg u eerst de actuele richtlijnen van de producent!
- Lees u de instructies voor de installatie helemaal door en volg de aanwijzingen nauwgezet op!
- Dit product is alleen geschikt voor voertuigen met een stuur aan de linkerkant!
- Wanneer het product wordt gewijzigd of niet op correcte wijze wordt gebruikt, vervallen alle garanties en alle rechten op ondersteuning bij de inbouw.

Aan deze informatie en afbeeldingen kunnen geen rechten worden ontleend. Wijzigingen voorbehouden ten aanzien van constructie, uitrusting, kleur en/of eventuele misrekening/vergissing. De Duitstalige tekst van deze gebruiksaanwijzing is bindend!

Wij dragen geen enkele aansprakelijkheid voor technische en/of elektronische wijzigingen alsmede software-updates die worden verricht na de eerste inbedrijfstelling van de elektrische set door de autofabrikant en die bijvoorbeeld leiden tot fouten in het functioneren van de aanhangerstekkerdoos en/of de randapparatuur!

Afhankelijk van de soort aanhangermodule die in de elektrische set wordt gebruikt, kan de interactie met het voertuignetwerk beperkt of zelfs onmogelijk zijn. Met de specifieke diagnostische systemen van de autofabrikant is geen toegang mogelijk tot foutenlogboeken die zich in de module zelf bevinden.

Foutrapportages ten aanzien van de werking van de aanhanger, die kunnen worden gegenereerd tijdens testprocedures door het diagnostische systeem van de autofabrikant, zijn soms te herleiden tot een incorrecte aansluiting en/of activering van het aanhangersysteem.

### Wij raden u aan

- de foutrapportages van uw voertuig te inspecteren, en de nodige reparaties te verrichten, voor aanvang van elk montagewerk!
- uw aanhangermodule indien nodig los te koppelen van de kabelset, waarna u de diagnoseprocedure opnieuw opstart!
- in geval van functionele problemen niet langer dan een half uur te zoeken naar een fout, maar contact op te nemen met onze hotline!



**HOTLINE** +49 5246 921019  
support@jaeger-automotive.de

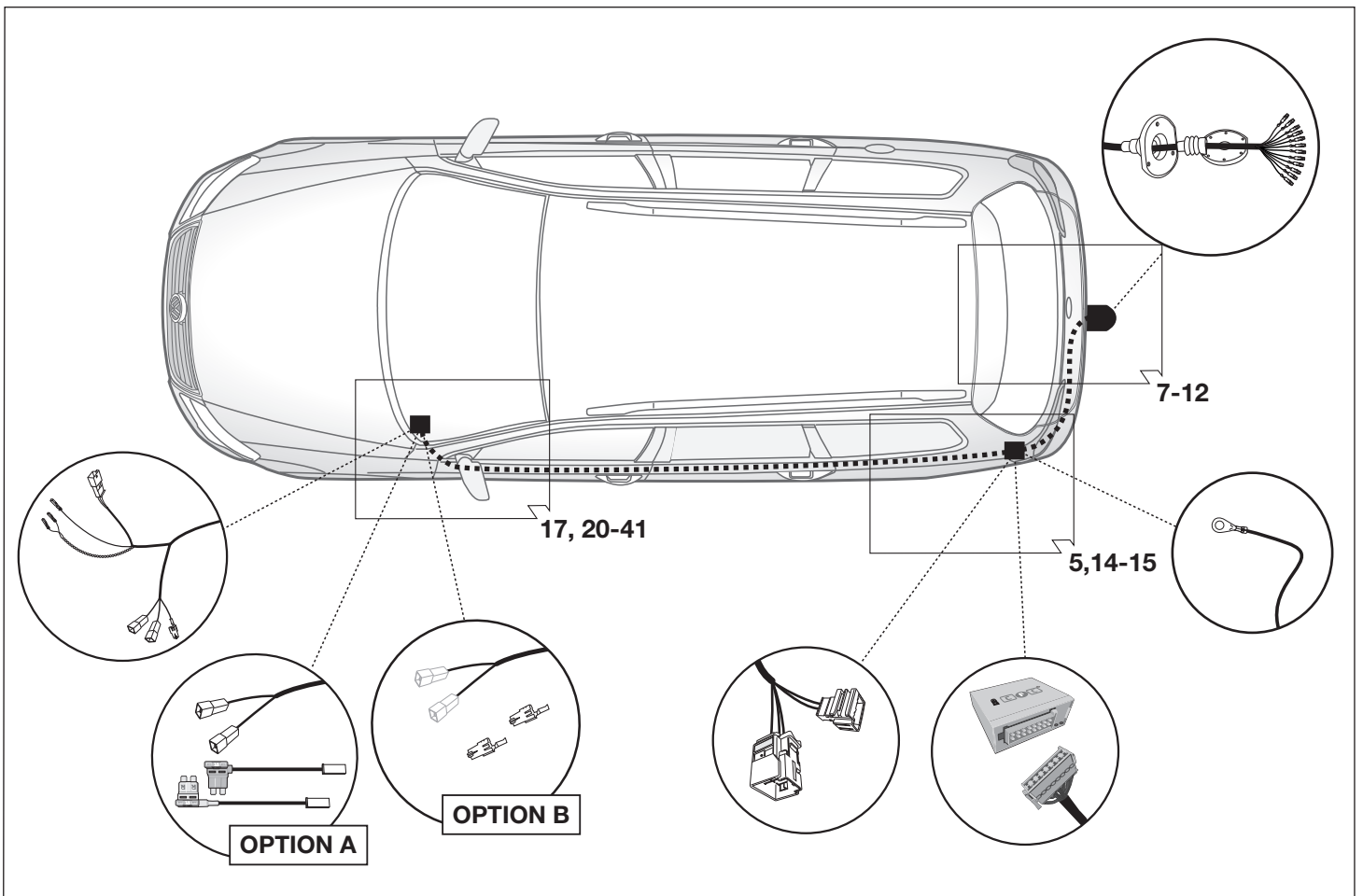
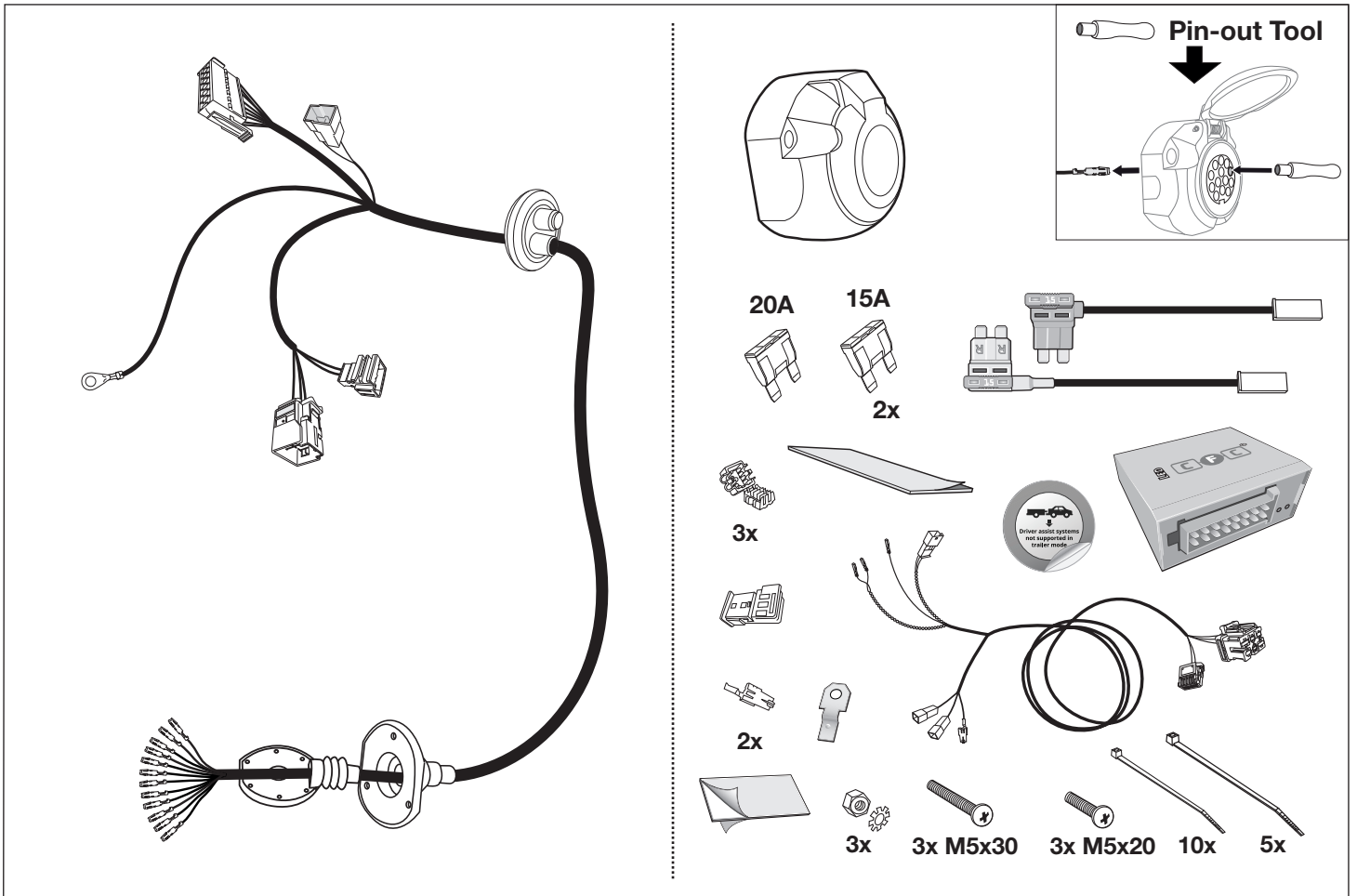

# Werkzeuge - Tools - Outils - Utensile - Herramientas - Werktuigen

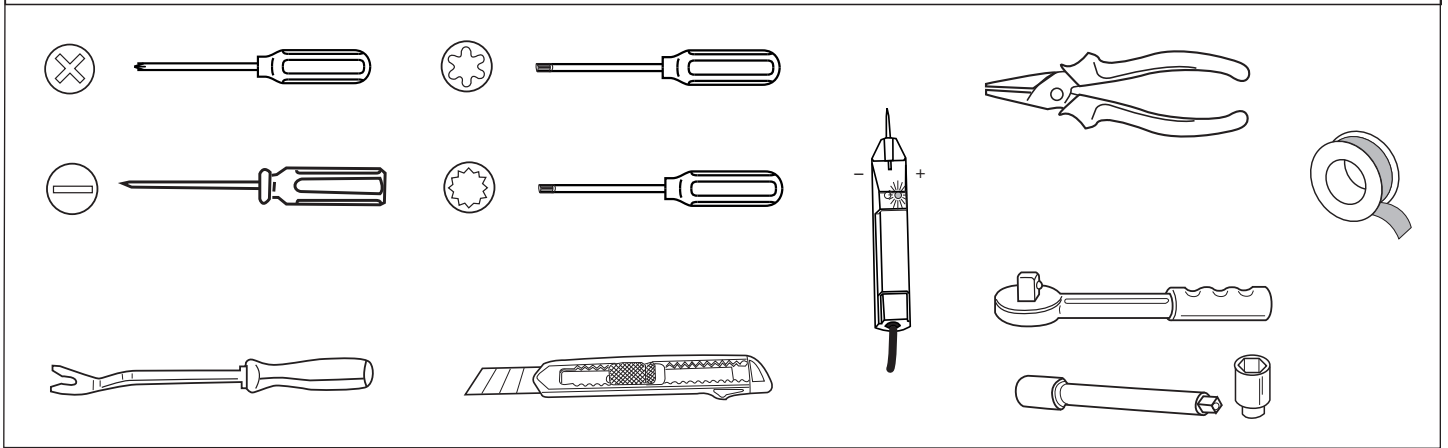

**Mit**  
**Anhänger-Vorbereitung!**

**Ohne**  
**Anhänger-Vorbereitung!**

<b>ACHTUNG!</b>	<b>ATTENTION!</b>	<b>ATTENTION!</b>	<b>ATTENZIONE!</b>	<b>¡ATENCIÓN!</b>	<b>ATTENTIE!</b>
<b>(D)</b>	<b>(GB)</b>	<b>(F)</b>	<b>(I)</b>	<b>(E)</b>	<b>(NL)</b>
Die Kühlerleistung des Fahrzeuges muß bei Nachrüstung einer Anhängerkupplung möglicherweise erhöht werden! Bitte unbedingt Herstellerangaben beachten!!	The vehicle's cooling capacity may have to be increased when retrofitting a trailer coupling! You must observe the manufacturer's instructions!!	Il peut s'avérer nécessaire d'augmenter la puissance du radiateur du véhicule lorsque celui est équipé ultérieurement d'un attelage remorque! Respecter impérativement les instructions du constructeur!!	La capacità di raffreddamento del veicolo, quando si applica un gancio di traino, si deve possibilmente aumentare! Si prega di osservare tassativamente le indicazioni del produttore!!	¡Es posible que haya que aumentar la capacidad del radiador en caso de reequipar un acoplamiento de remolque! ¡Rogamos tener en cuenta las instrucciones de fabricante sin falta!	Het koelvermogen van het voertuig moet mogelijk worden verhoogd als achteraf een aanhangerkoppeling wordt aangebracht! Absoluut de fabrieksopgaven in acht nemen a.u.b.!!

<b>ACHTUNG!</b>	<b>ATTENTION!</b>	<b>ATTENTION!</b>	<b>ATTENZIONE!</b>	<b>¡ATENCIÓN!</b>	<b>ATTENTIE!</b>
Um Störungen und Schäden am Bordnetz zu vermeiden, <b>muß</b> die Massepolklemme unbedingt <b>vor Beginn aller Arbeiten</b> von der Fahrzeugbatterie getrennt werden!  Insbesondere bei Arbeiten und Anschlüssen am CAN-Datenbus kann bei nicht abgeklemmter Batterie sowohl das Anhängermodul als auch das fahrzeugseitige Bordnetzsteuergerät beschädigt werden!  Bitte Herstellervorschriften beim Ab- und Anklemmen der Fahrzeugbatterie beachten!	In order to avoid malfunctions and damage to the vehicle's electrical system the earth terminal <b>must be disconnected</b> from the vehicle's battery <b>before starting work!</b>  Both the trailer module and the vehicle's control unit for the electrical system can be damaged during work on the CAN data bus connections if the battery is not disconnected!  Please pay attention to the manufacturer's instructions when disconnecting and reconnecting the vehicle's battery!	Afin d'éviter tout dysfonctionnement ou endommagement du circuit de bord, <b>il est indispensable</b> de débrancher la pince de masse de la batterie du véhicule <b>avant le début de toute opération!</b>  En particulier s'il s'agit de travaux et de branchements effectués sur le bus de données CAN, si la batterie n'est pas débranchée, le module remorque aussi bien que le dispositif de commande de circuit de bord du véhicule risquent d'être endommagés!  Veuillez respecter les directives du fabricant lors du branchement et du débranchement de la batterie du véhicule!	Per evitare disturbi e danni alla rete di distribuzione elettrica, l'espansione polare a massa <b>deve</b> essere assolutamente scollegata dalla batteria del veicolo <b>prima dell'inizio dei lavori!</b>  In particolare durante i lavori e gli allacciamenti al bus di dati CAN, se la batteria non è scollegata si possono danneggiare sia la centralina rimorchio, sia la centralina della rete di distribuzione elettrica del veicolo!  Attenersi alle indicazioni del costruttore per scollegare e ricollegare la batteria del veicolo!	¡Para evitar fallos y defectos en el sistema eléctrico de a bordo <b>es imprescindible</b> separar al terminal de puesta a tierra de la batería del vehículo <b>antes de realizar cualquier trabajo!</b>  ¡Particularmente al realizar trabajos y conexiones al bus de datos CAN puede estropearse tanto el módulo para remolques como el regulador del sistema eléctrico de a bordo del vehículo si no se ha desconectado la batería!  ¡Rogamos observar las instrucciones del fabricante al conectar y desconectar la batería del vehículo!	Om storingen en schade aan de elektrische bedrading te vermijden <b>moet</b> de massapoolklem absoluut <b>vóór aanvang van alle werkzaamheden</b> worden losgekoppeld van de voertuigaccu!  Vooral bij werkzaamheden aan aansluitingen op de CAN-databus kan zowel de aanhangermodule als de voertuigzijdige regelenheid voor de elektrische installatie beschadigd worden, als de accu niet ontkoppeld is!  Fabrieksvoorschriften bij het vast- en loskoppelen van de voertuigaccu in acht nemen a.u.b.!



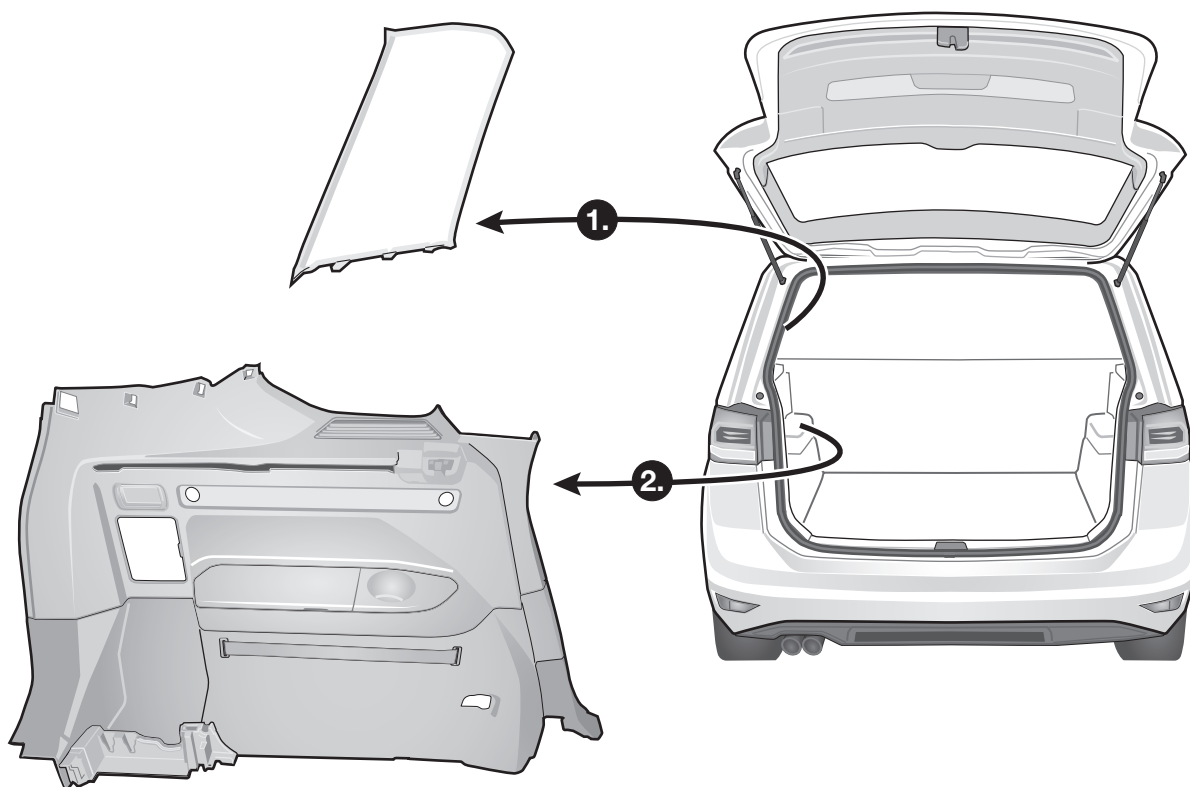
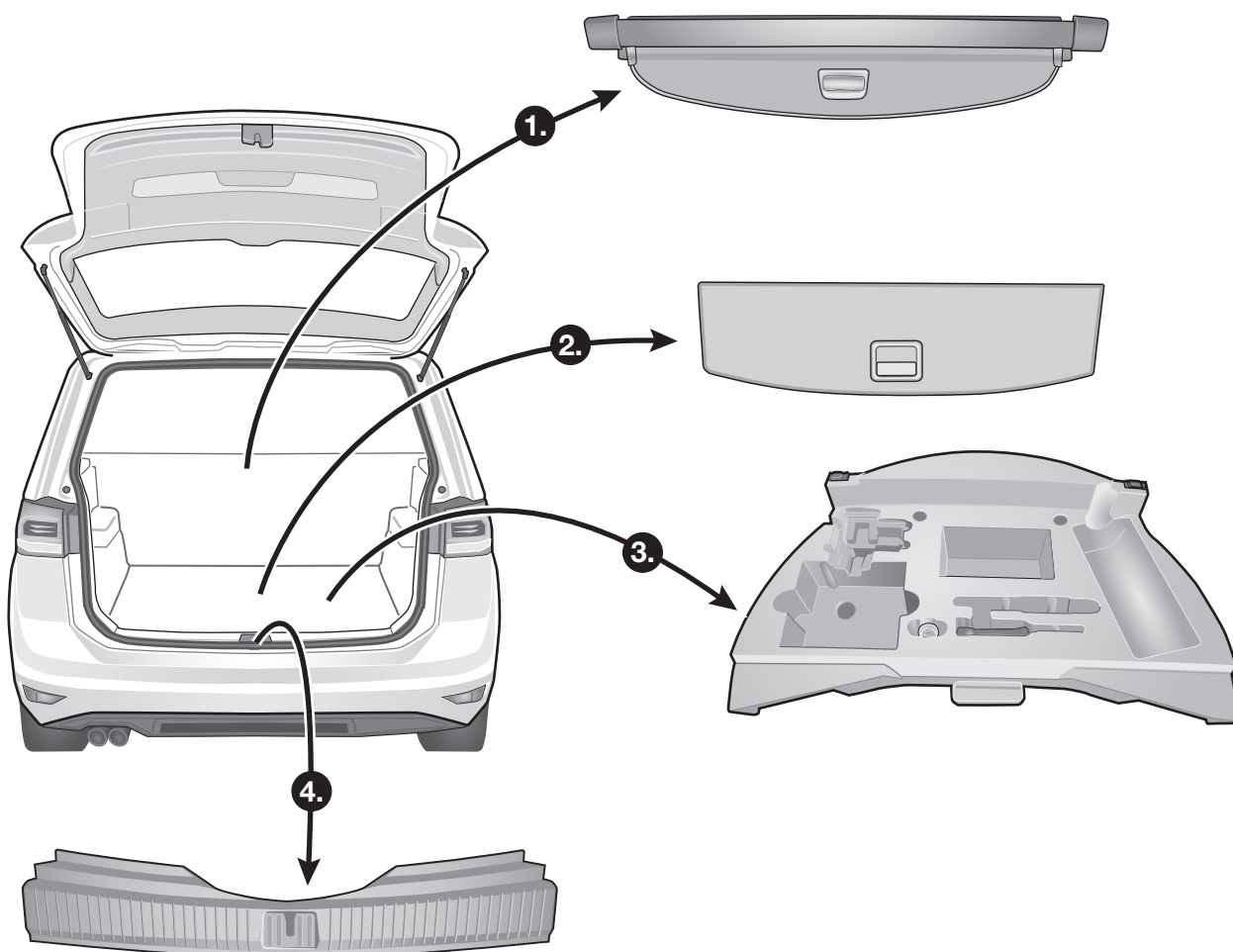

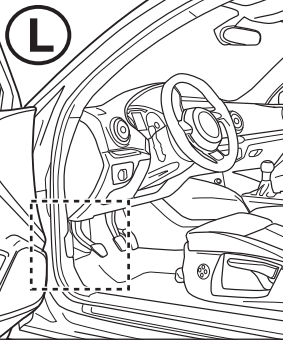

L



Nur bei Fahrzeugen ohne Anhänger Vorbereitung  
Only for vehicles without trailer preparation

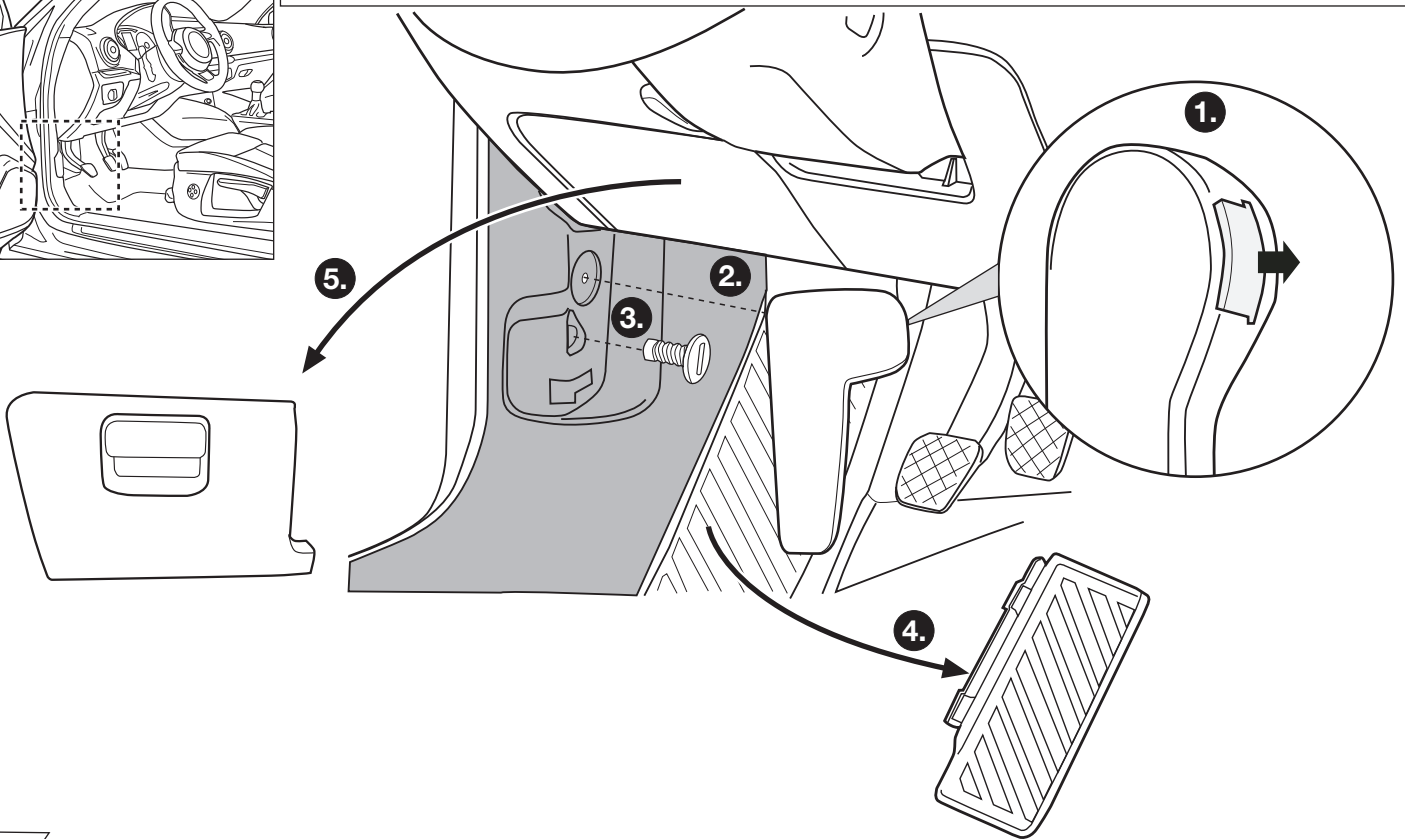

3

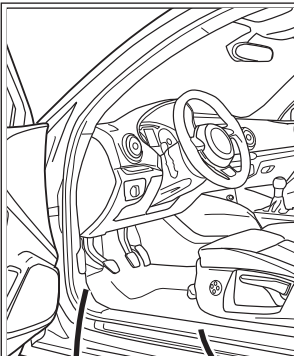

Nur bei Fahrzeugen ohne Anhänger Vorbereitung  
Only for vehicles without trailer preparation

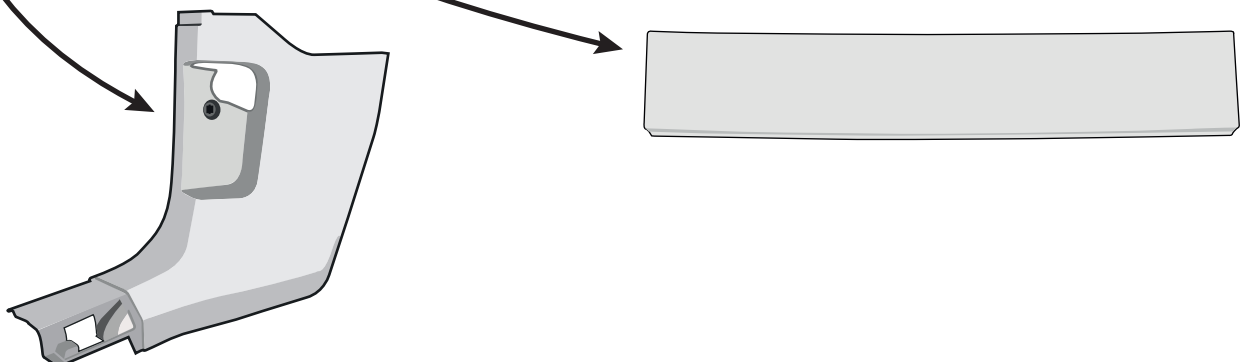

4

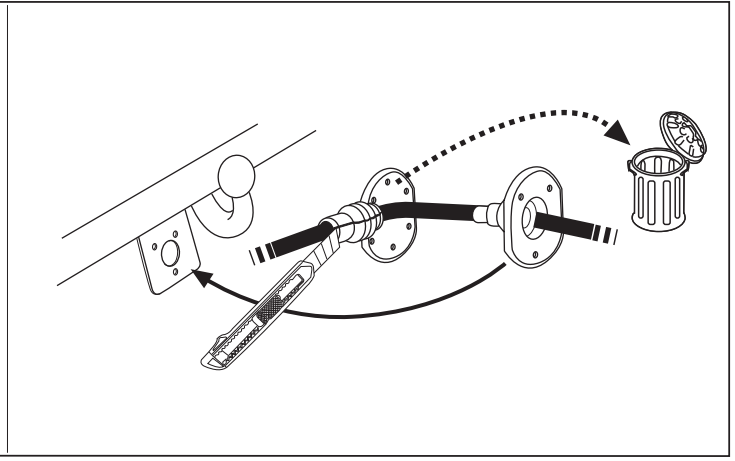
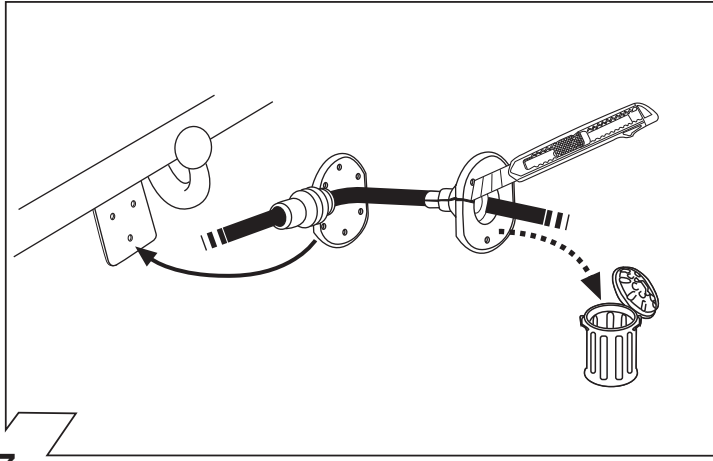
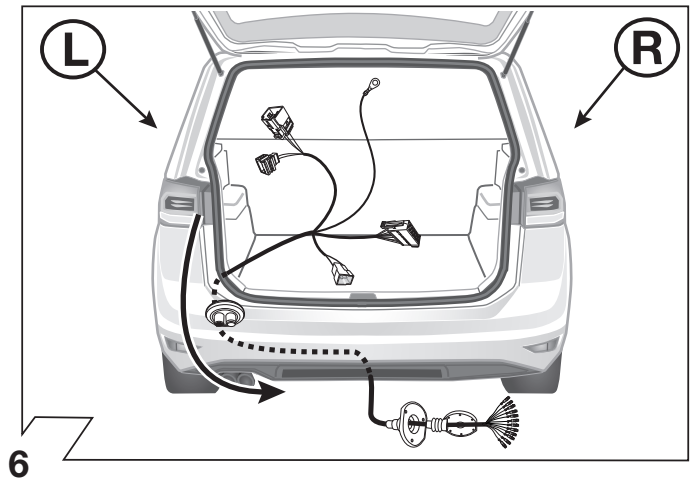
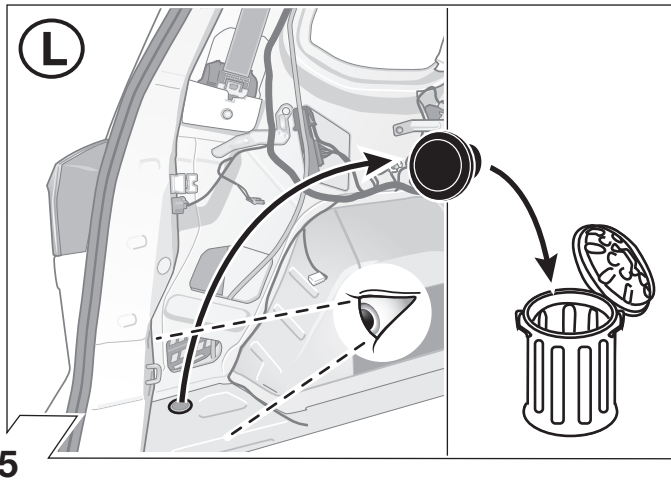

	GB	D	E	F	I	P	NL	DK	N	S	FIN	CZ	H	PL
<b>BK</b>	Black	Schwarz	Negro	Noir	Nero	Preto	Zwart	Sort	Svart	Svart	Musta	Černá	Fekete	Czarny
<b>RD</b>	Red	Rot	Rojo	Rouge	Rosso	Vermelho	Rood	Rød	Rød	Röd	Punainen	Červená	Piros	Czerwony
<b>GN</b>	Green	Grün	Verde	Vert	Verde	Verde	Groen	Grøn	Grønt	Grön	Vihreä	Zelená	Zöld	Zielony
<b>OR</b>	Orange	Orange	Naranja	Orange	Arancione	Laranja	Oranje	Orange	Orange	Orange	Oranssi	Oranzová	Narancs	Pomarańczowy
<b>VT</b>	Violet	Violett	Violeta	Violet	Viola	Violeta	Violet	Violet	Fiolet	Violet	Violetti	Fialová	Ibolya	Fioletowy
<b>PK</b>	Pink	Pink	Pink	Rose	Rosa	Cor-de-Rosa	Paars	Pink	Pink	Rosa	Pinkki	Růžová	Rózsaszín	Różowy
<b>BL</b>	Blue	Blau	Azul	Bleu	Blu	Azul	Blauw	Blå	Blått	Blå	Sininen	Modrá	Kék	Niebieski
<b>YL</b>	Yellow	Gelb	Amarillo	Jaune	Giallo	Amarelo	Geel	Gul	Gult	Gul	Keltainen	Zlutá	Sárga	Żółty
<b>WT</b>	White	Weiss	Blanco	Blanc	Bianco	Branco	Wit	Hvid	Hvitt	Vit	Valkoinen	Bílá	Fehér	Biały
<b>BR</b>	Brown	Braun	Marrón	Brun	Marrone	Marrom	Bruin	Brun	Brunt	Brun	Ruskea	Hnědá	Barna	Brazowy
<b>GY</b>	Grey	Grau	Gris	Gris	Grigio	Cinzeno	Grijs	Grå	Grått	Grå	Harmaa	Sedá	Szürke	Szary

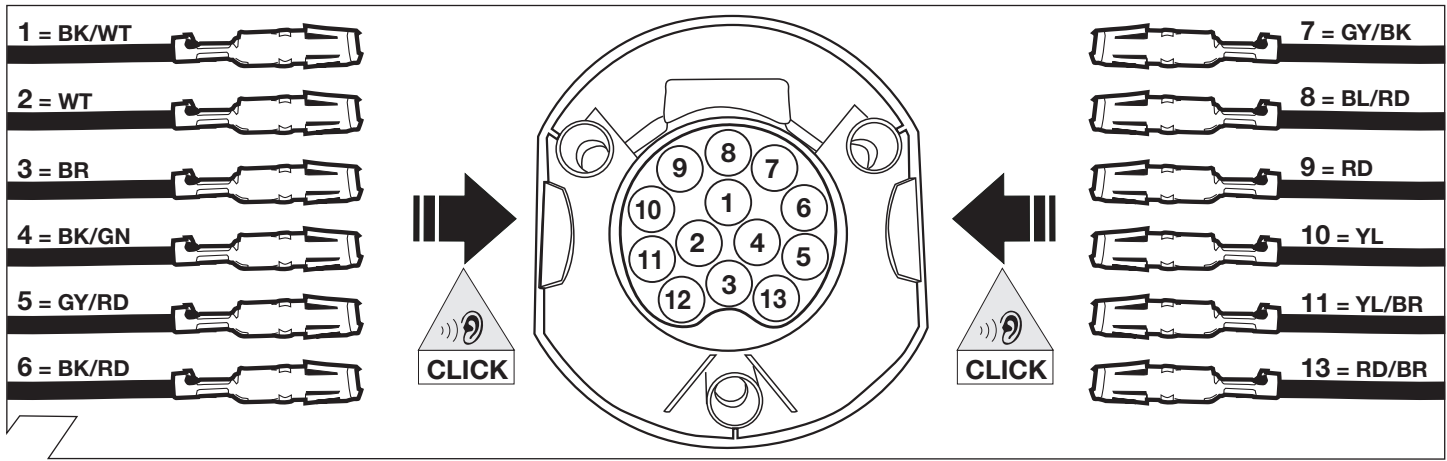



ISO 11446				
Belegung der Steckdose / Maximale Ausgangsleistung Socket configuration / Maximum power output Correspondance des contacts de la prise / Puissance de sortie maximale Abbinamento della presa / Uscita di alimentazione massima Indeling van de stekkerdoos / maximaal uitgangsvermogen				
	1/L	BK/WT	21W	
	2	WT	42W	
	3/31	BR		
	4/R	BK/GN	21W	
	5/58-R	GY/RD	52W	
	6/54	BK/RD	63W	
	7/58-L	GY/BK	52W	
	8	BL/RD	42W	
	9	RD	240W	
	10	YL	180W	
	11	YL/BR		
	12			
	13	RD/BR		

10

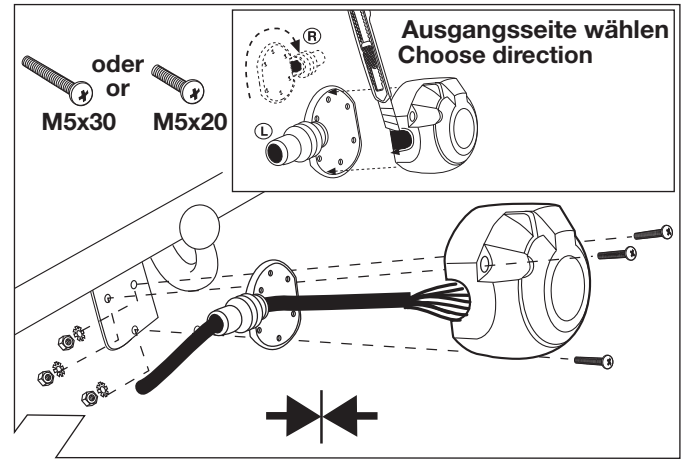

11

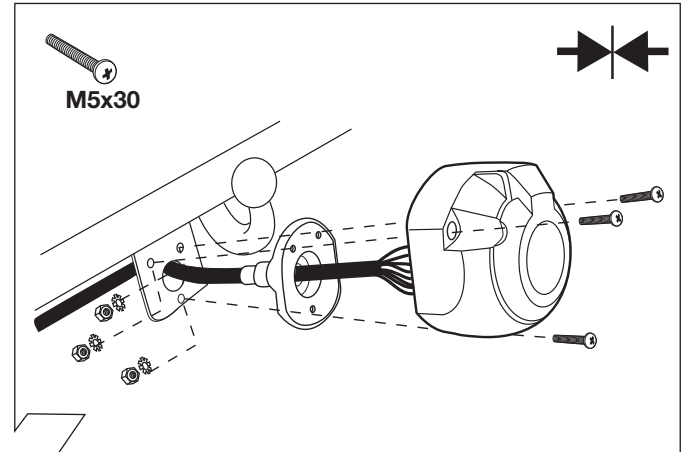

12

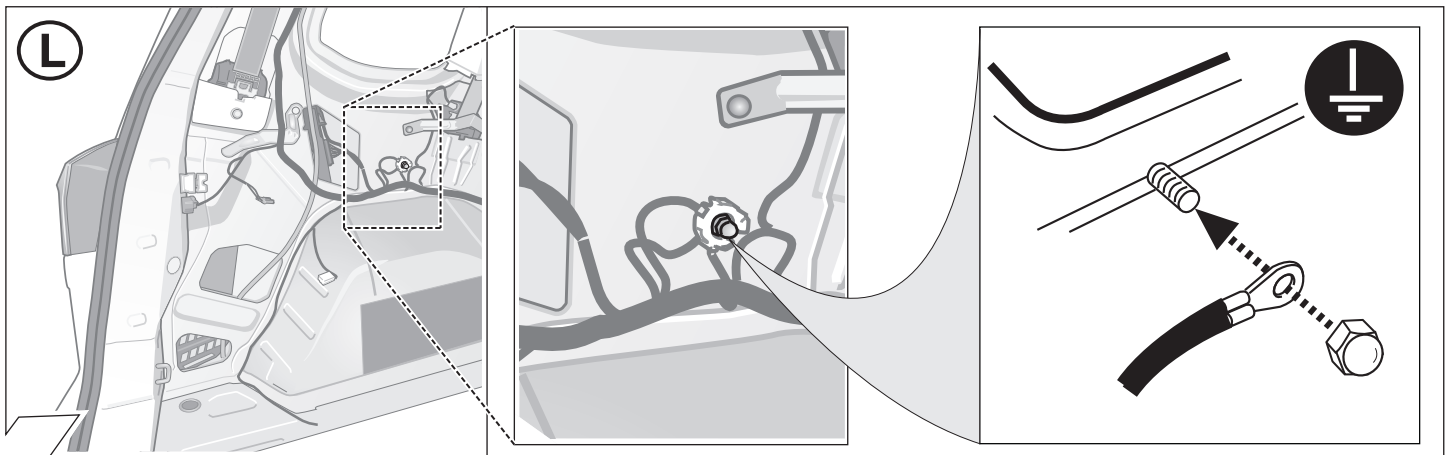

13

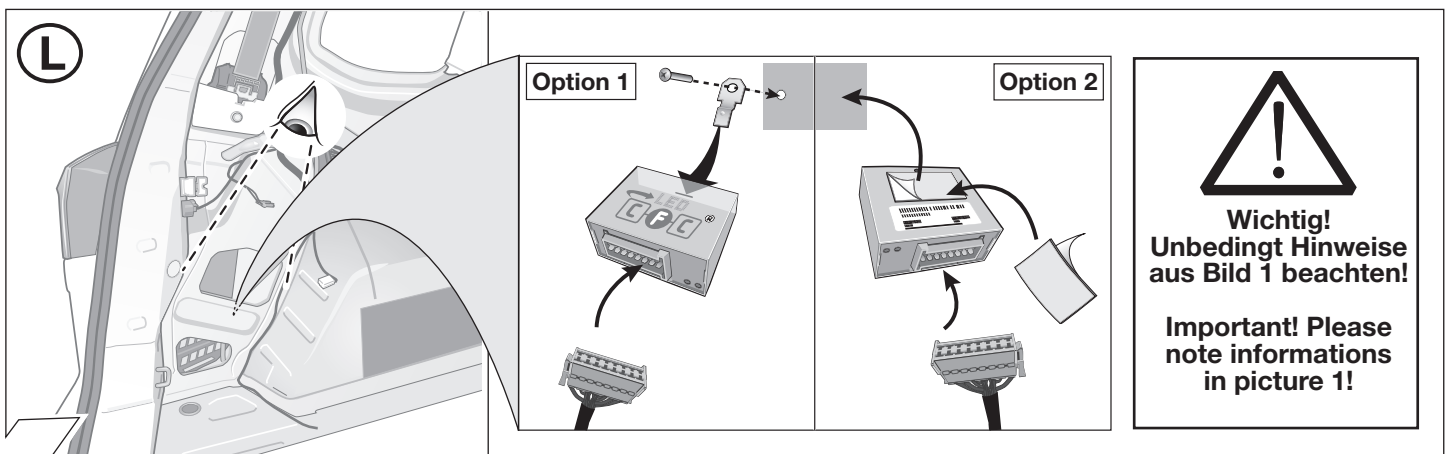

14

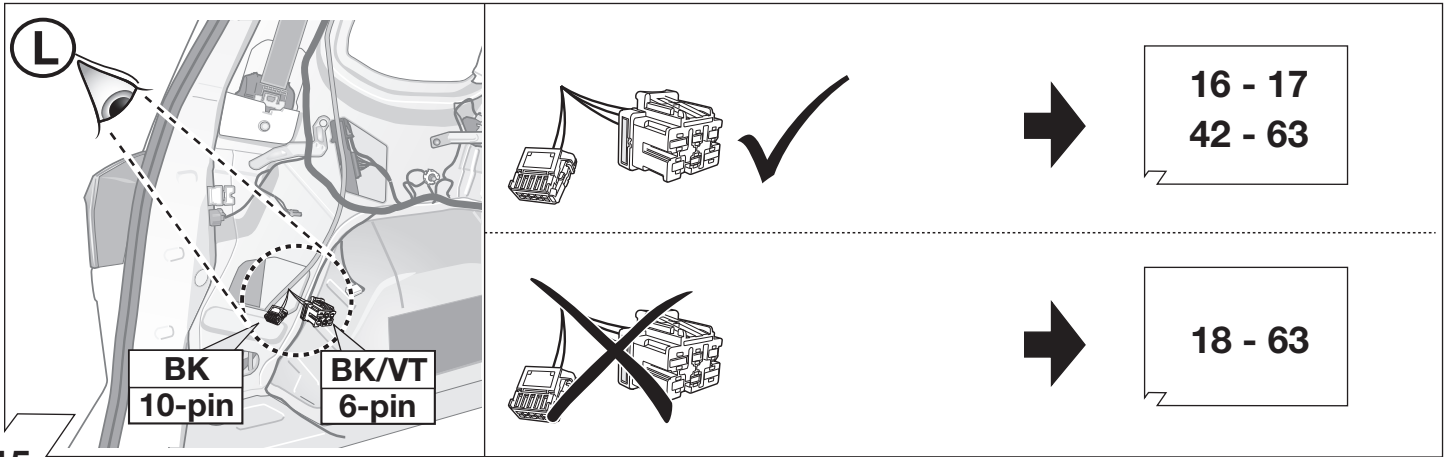

15

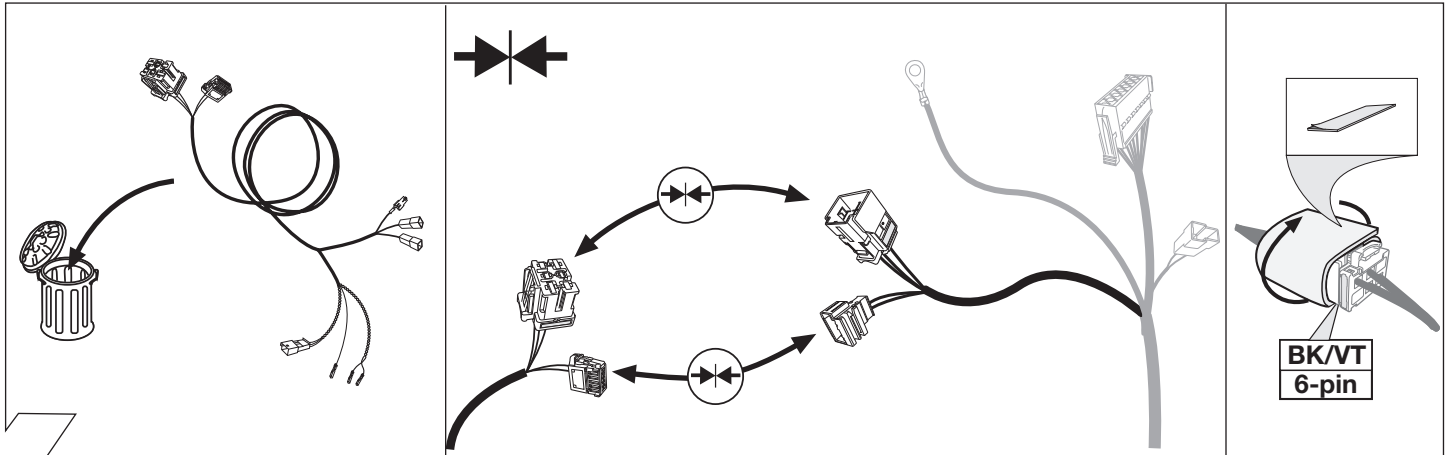

16

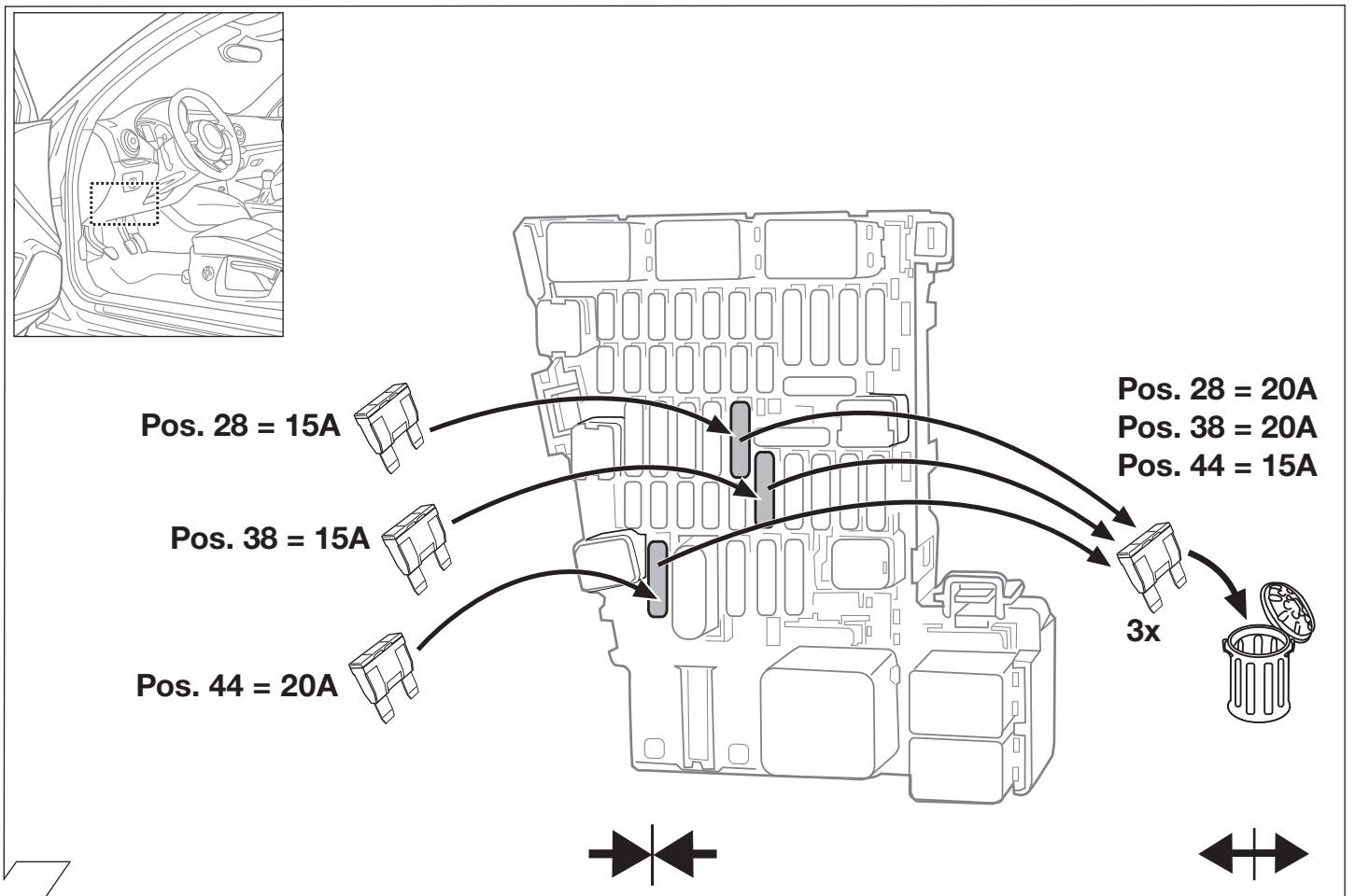

17

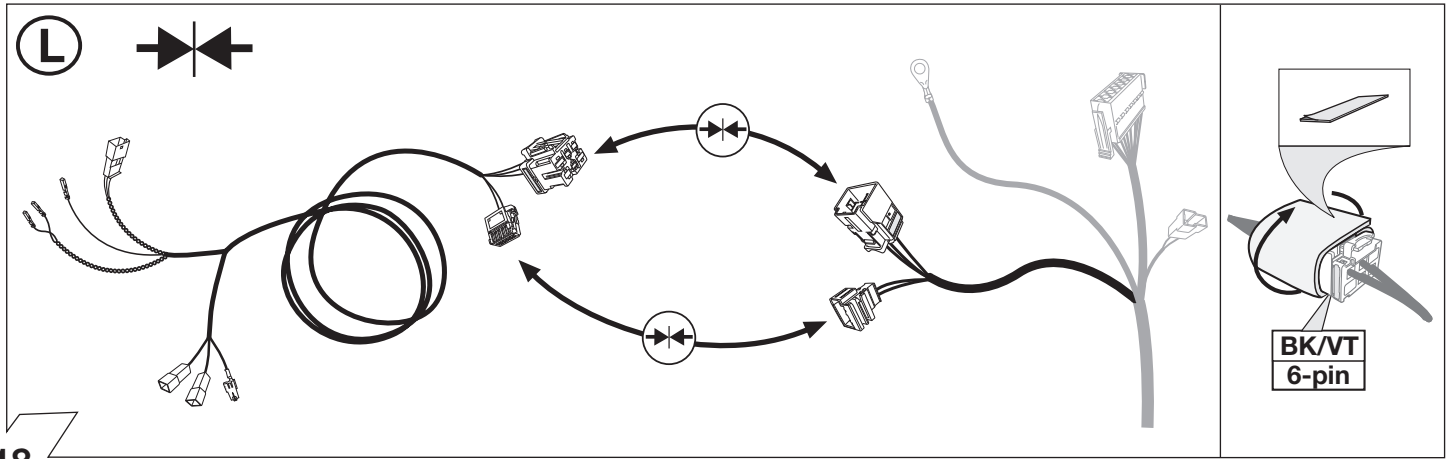

18

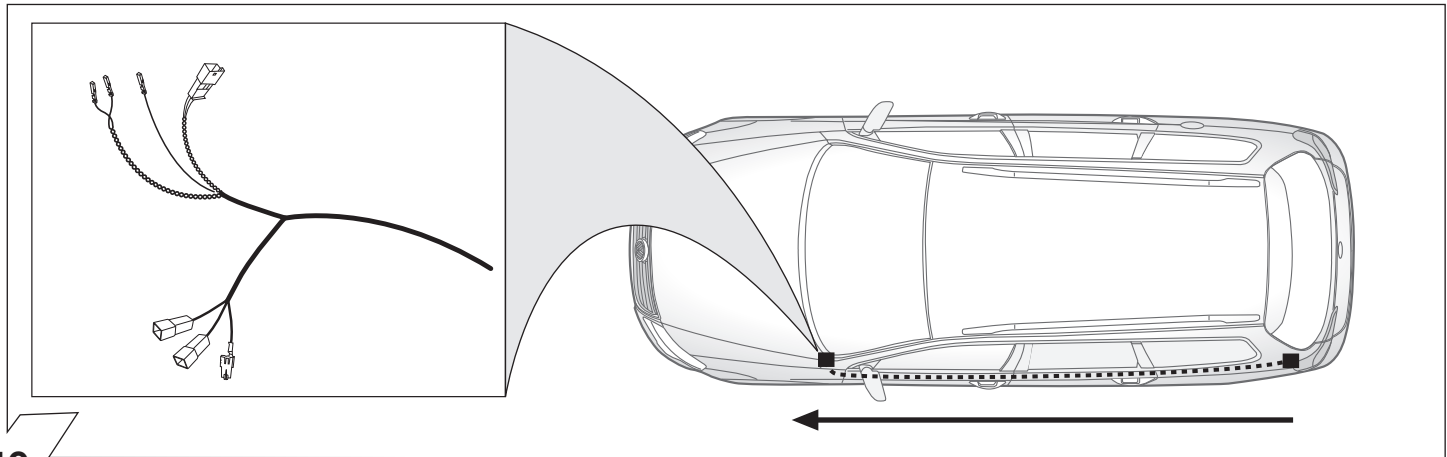

19

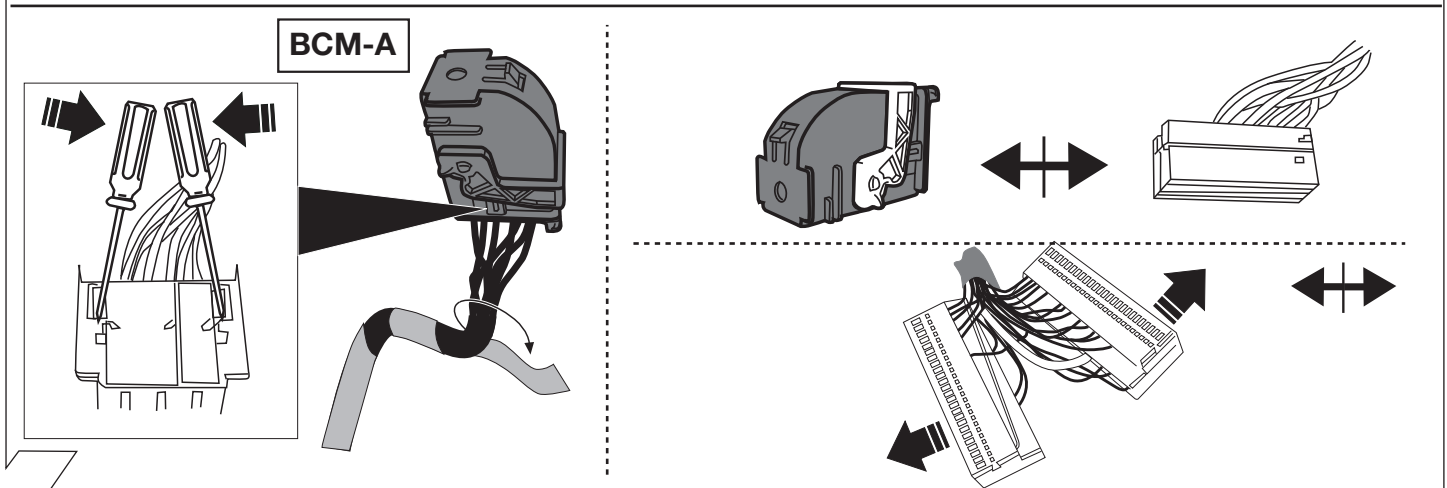
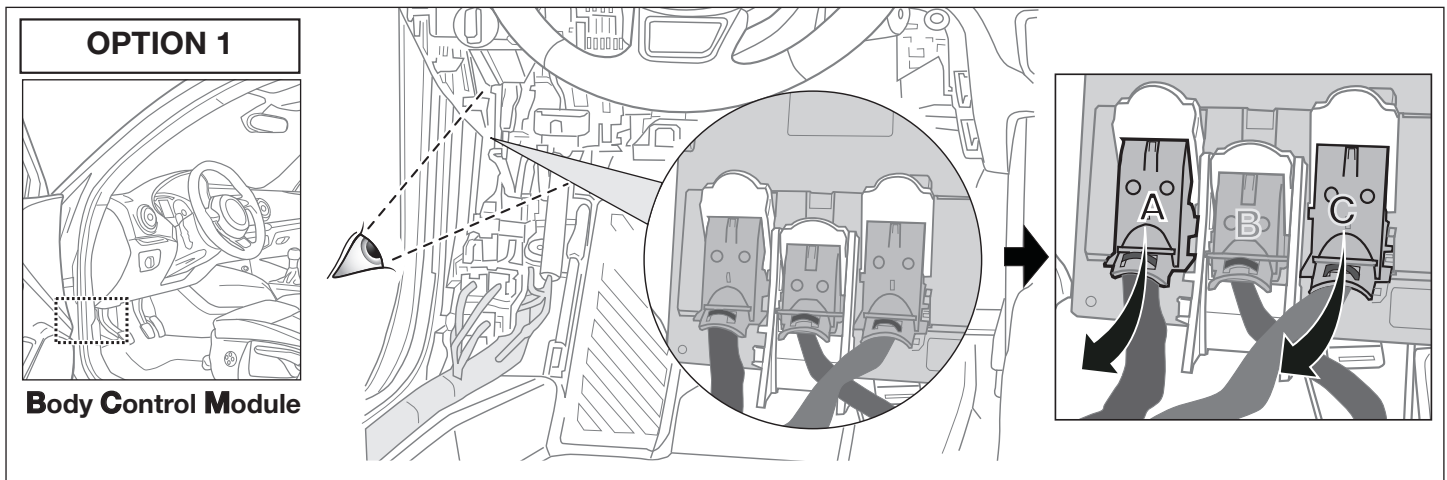

20

**OPTION 1 BCM-A**

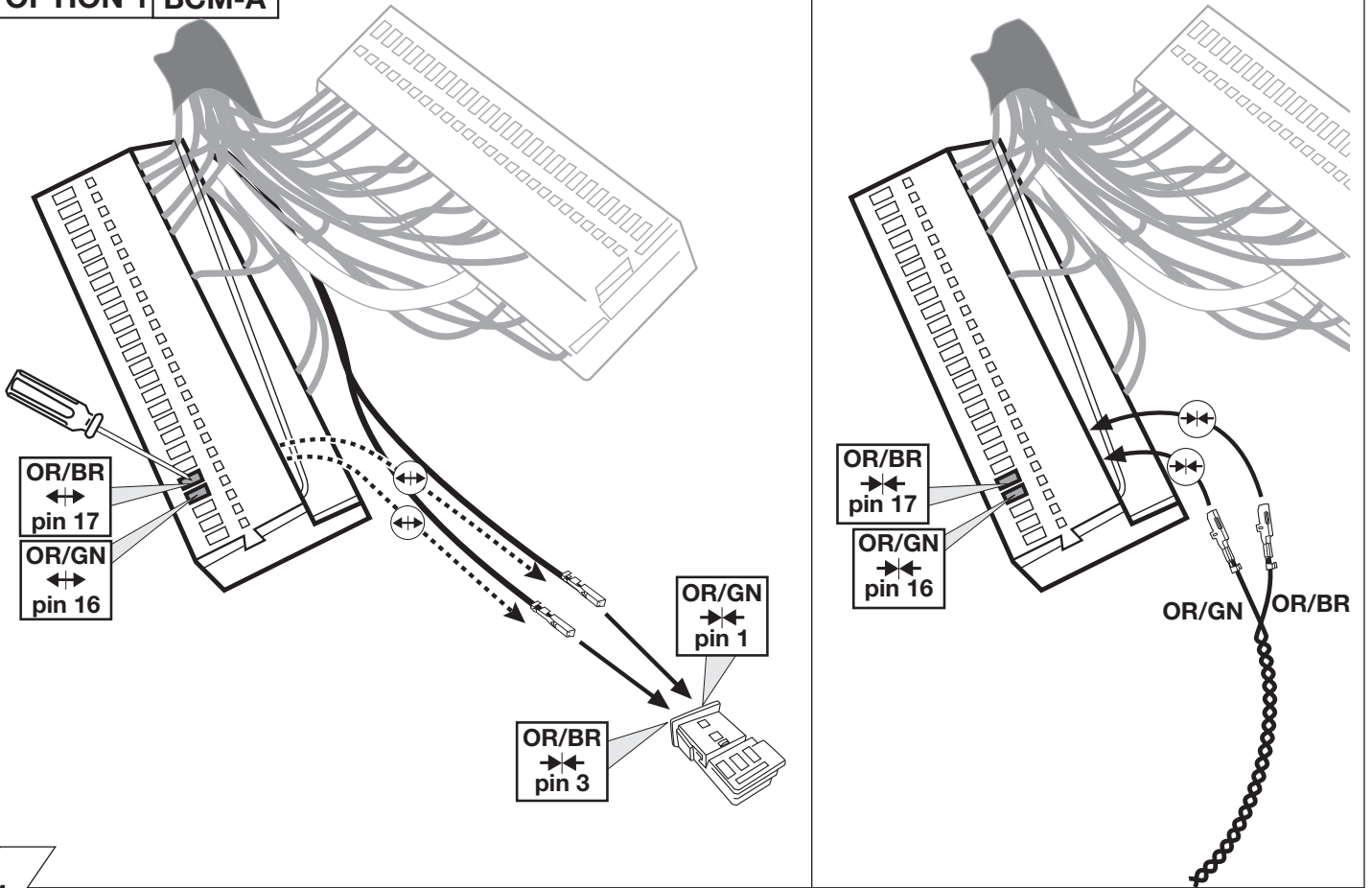

21

**OPTION 1 BCM-C**

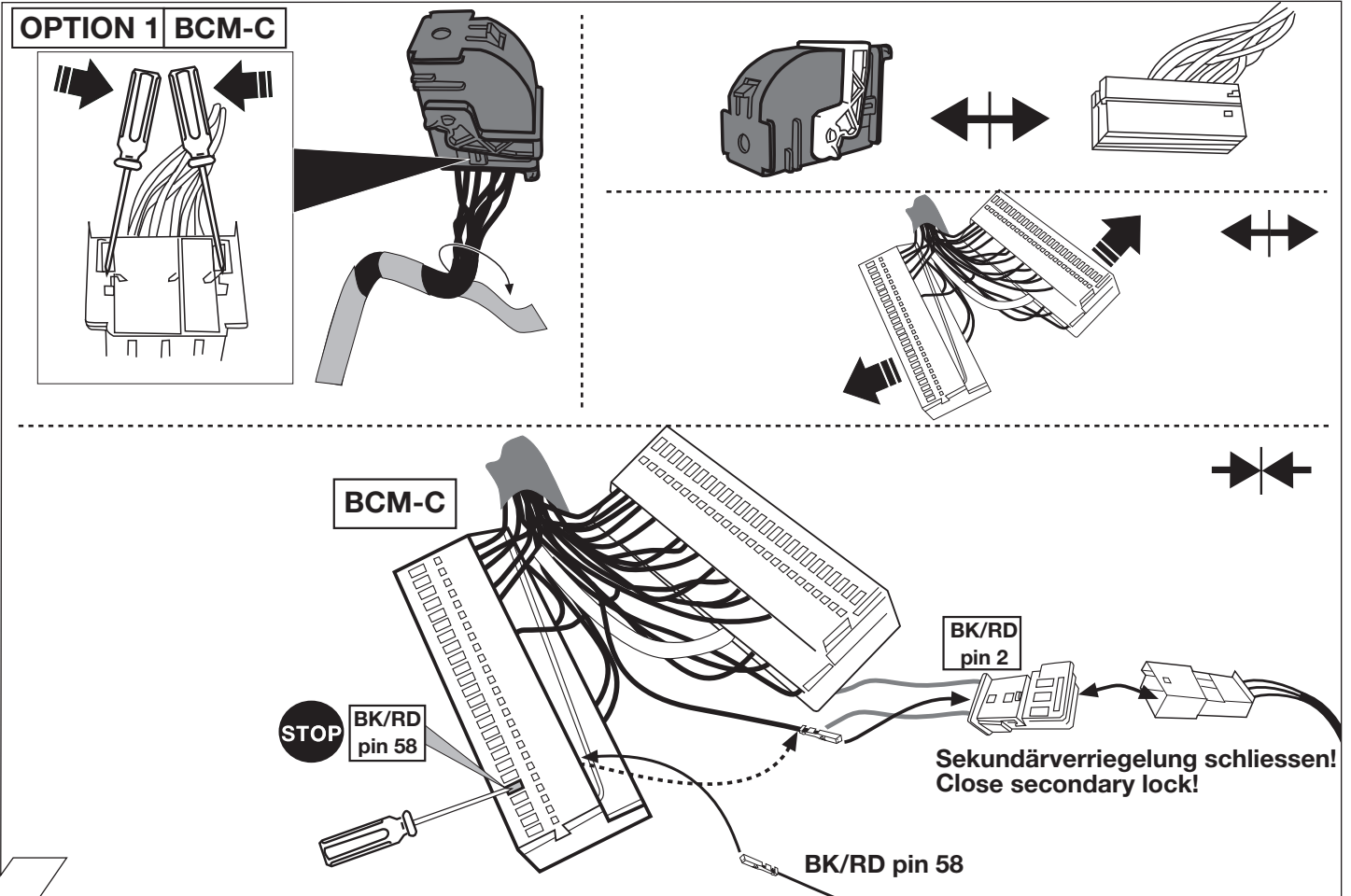

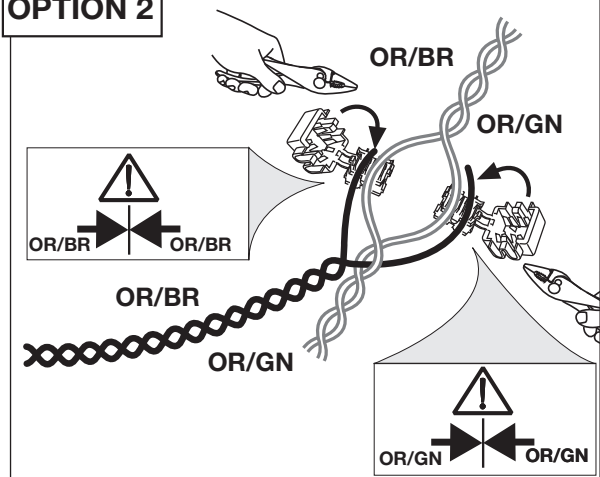

22

**OPTION 2**

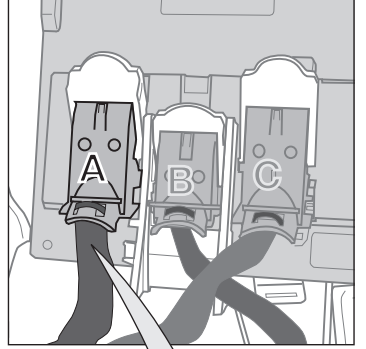

**!**  
**Wichtig!**  
**Unbedingt Hinweise**  
**aus Bild 1 beachten!**  
**Important! Please**  
**note informations**  
**in picture 1!**



**CAN-Data Wire**  

 OR/BR (Kammer/ chamber 17)  
 OR/GN (Kammer / chamber 16)

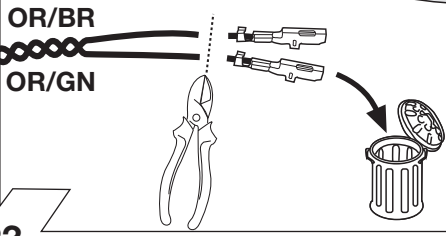
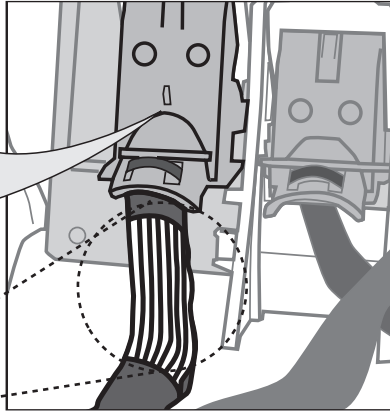
**Bordnetzsteuergerät**  
**Steckgehäuse A**  
**Network control unit**  
**connector A**

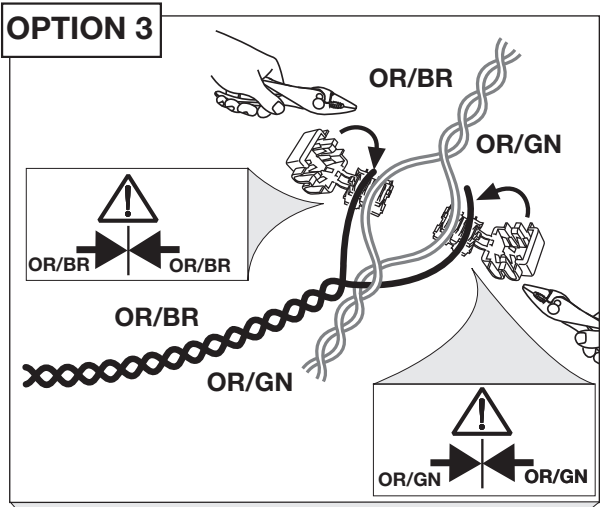

**OPTION 3**



**!**  
**Wichtig!**  
**Unbedingt Hinweise**  
**aus Bild 1 beachten!**  
**Important! Please**  
**note informations**  
**in picture 1!**

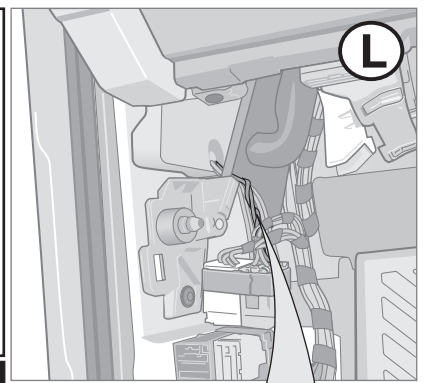

**CAN-Data Wire**  

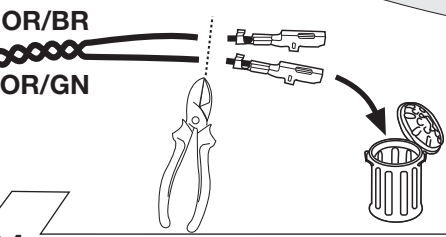
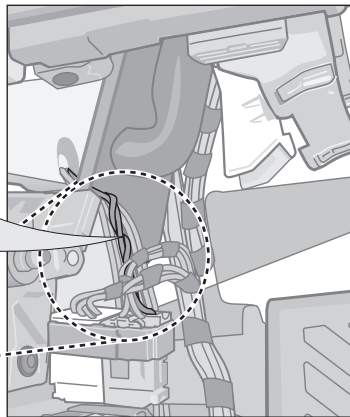
 OR/BR  
 OR/GN



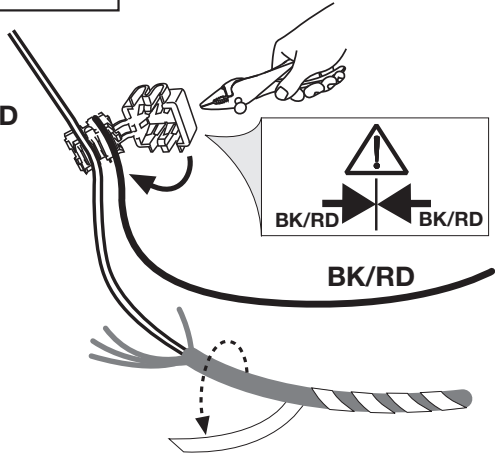

**OPTION 2 + 3**

BK/RD



**Wichtig!**  
Unbedingt Hinweise  
aus Bild 1 beachten!

**Important!** Please  
note informations  
in picture 1!

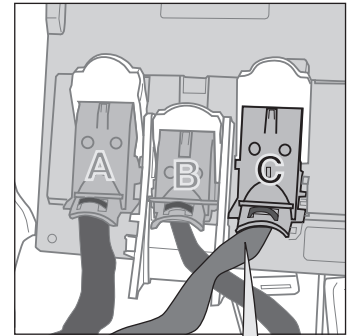

**STOP**

BK/RD

BK/RD Kammer 58  
BK/RD chamber 58

**Bordnetzsteuergerät  
Steckgehäuse C**  
Network control unit  
connector C

BK/RD

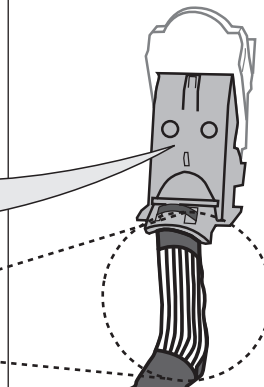
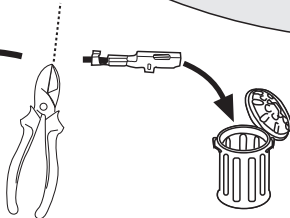

25

**OPTION 2 + 3**

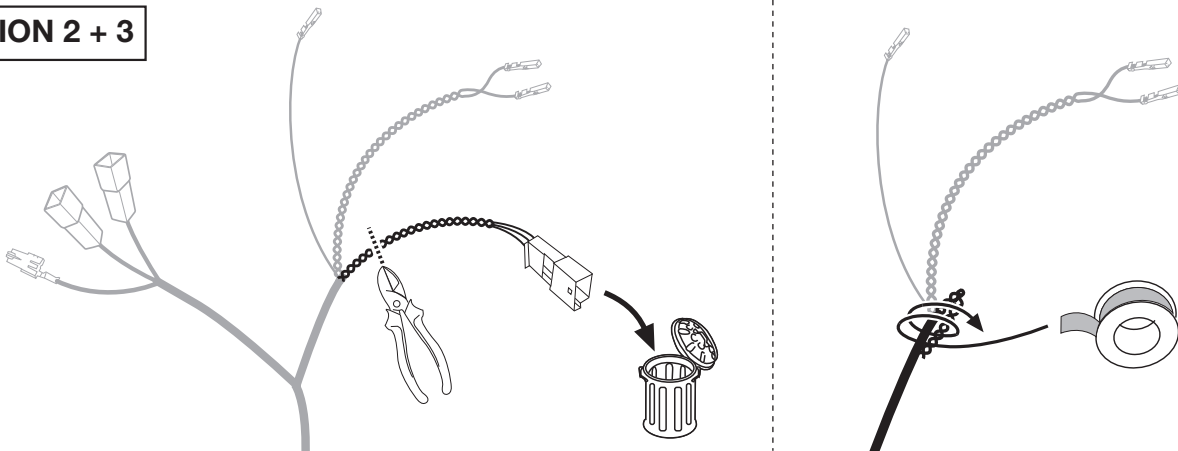

26

**B+/30  
Option A**

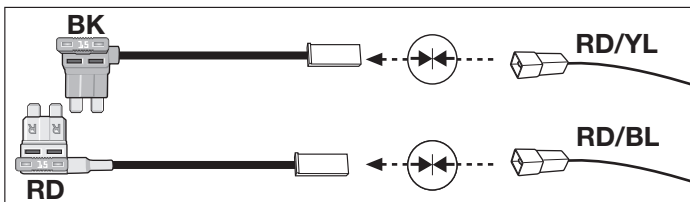

**28 - 32  
42 - 63**

**B+/30  
Option B**

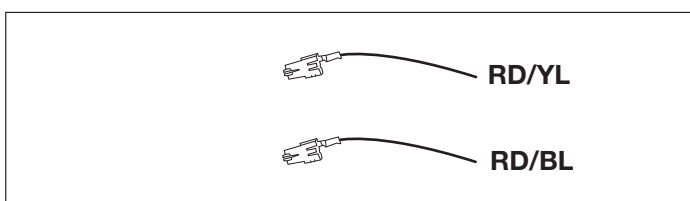

**33 - 63**

27

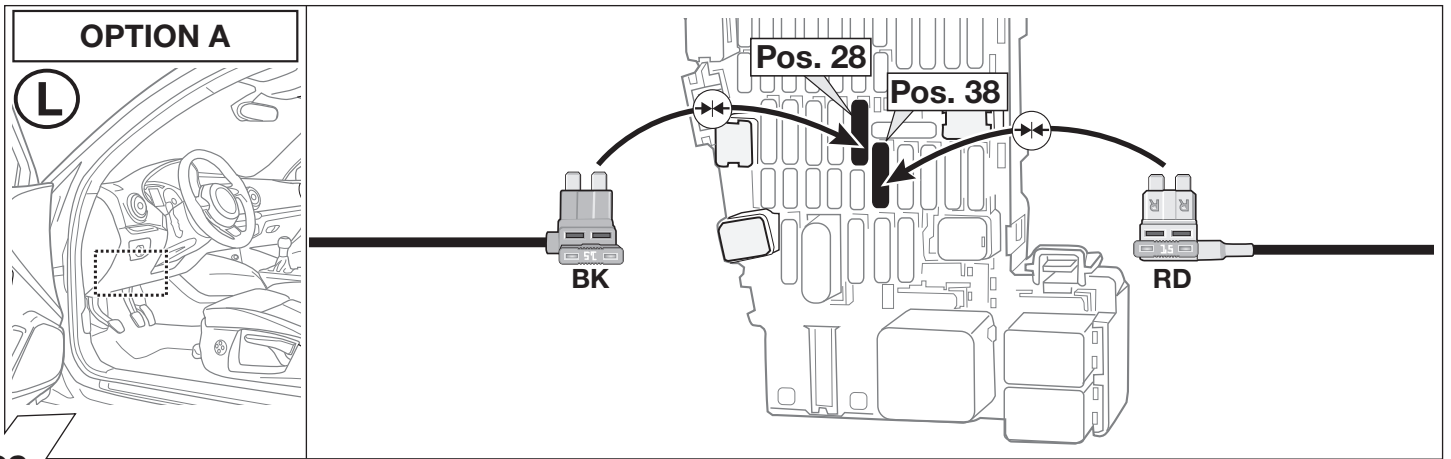

28

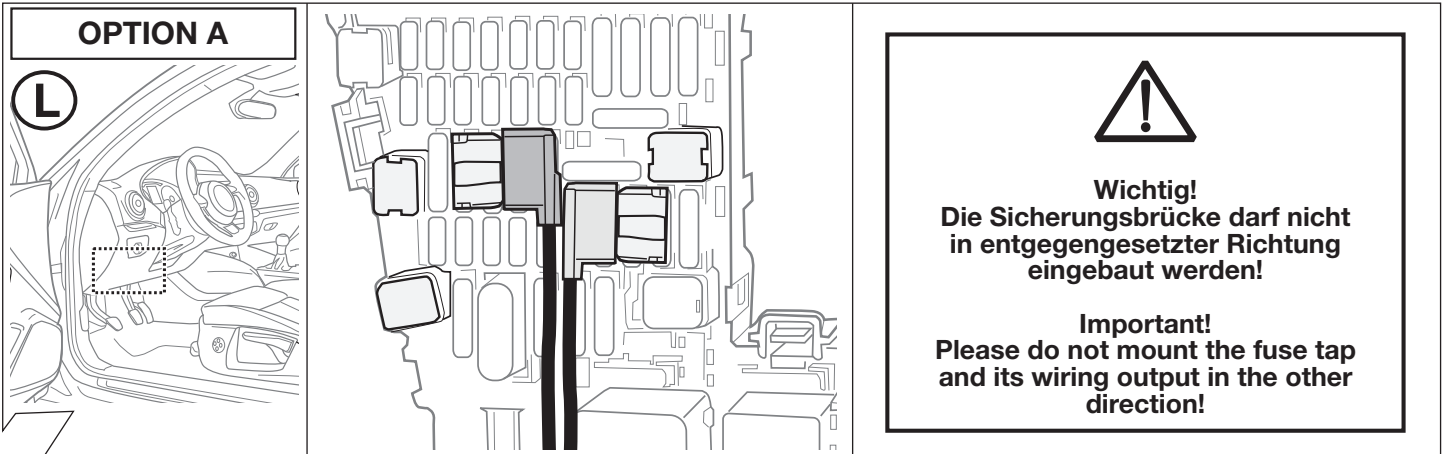

29

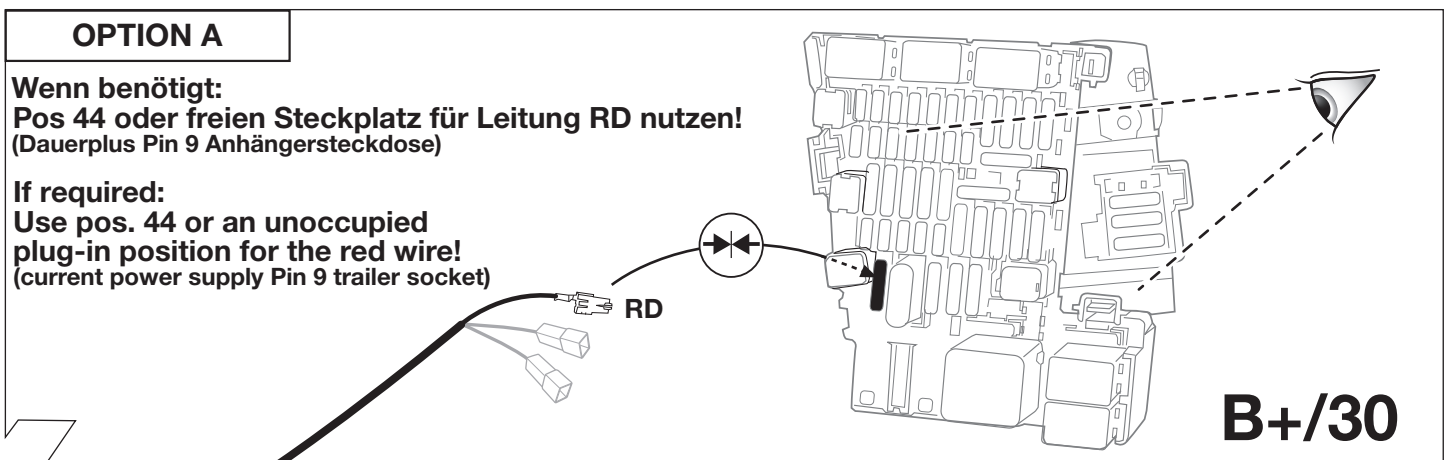

30

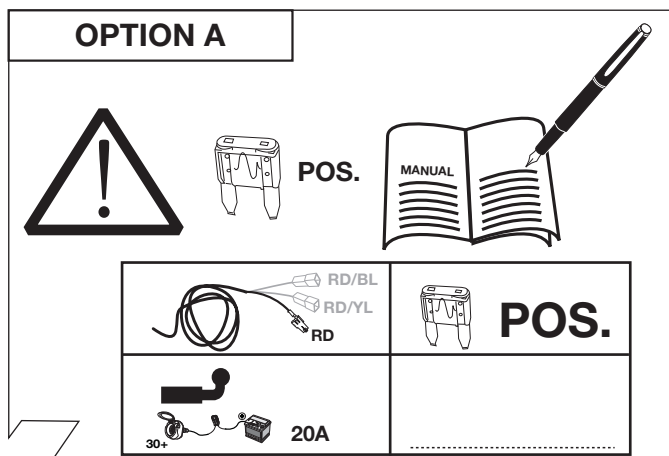

31

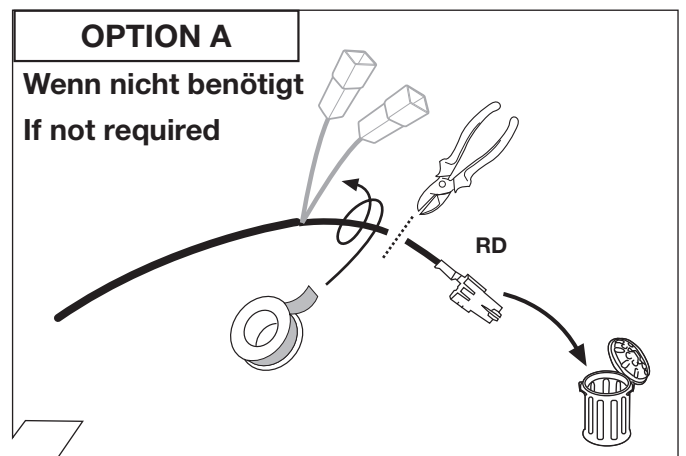

32

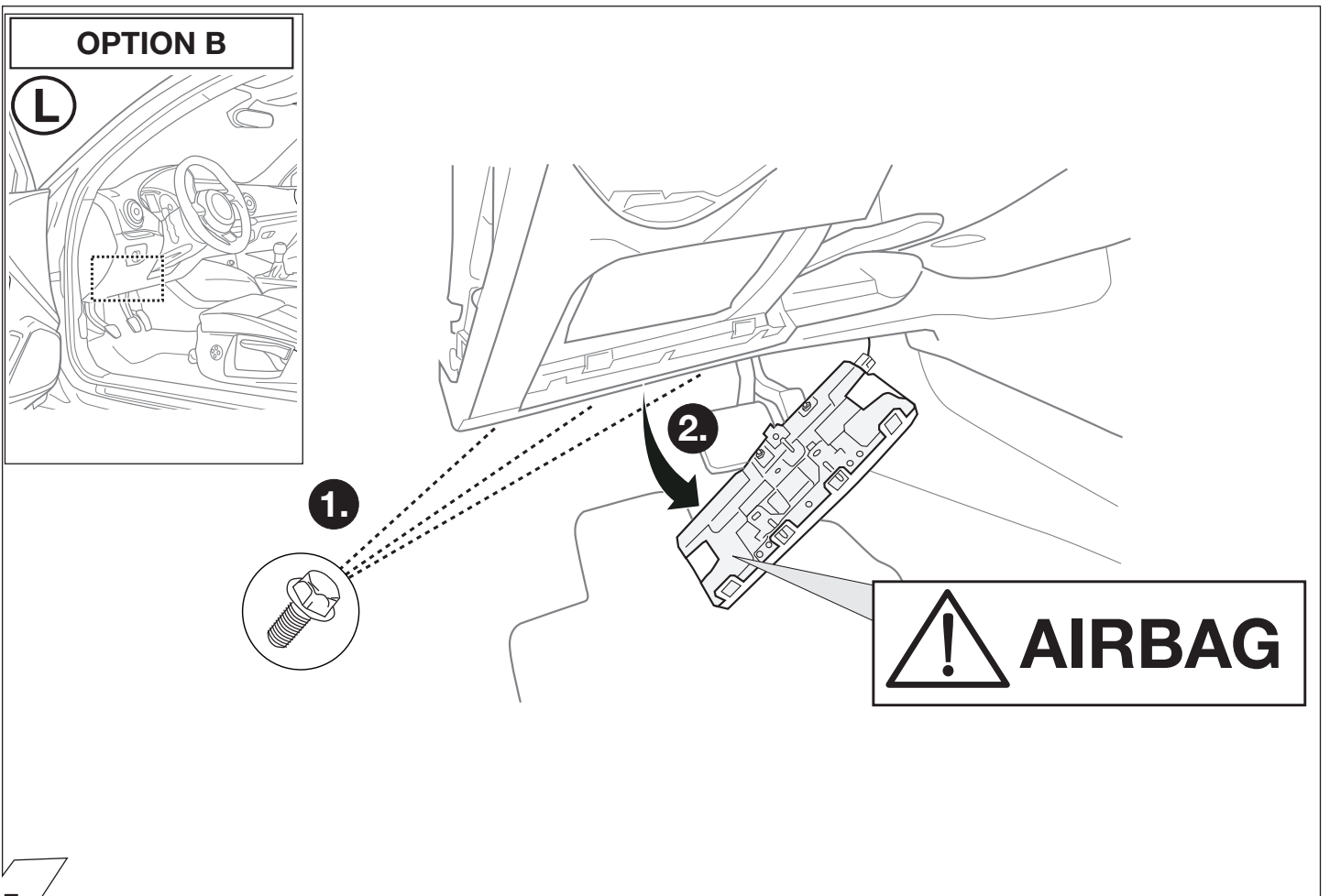
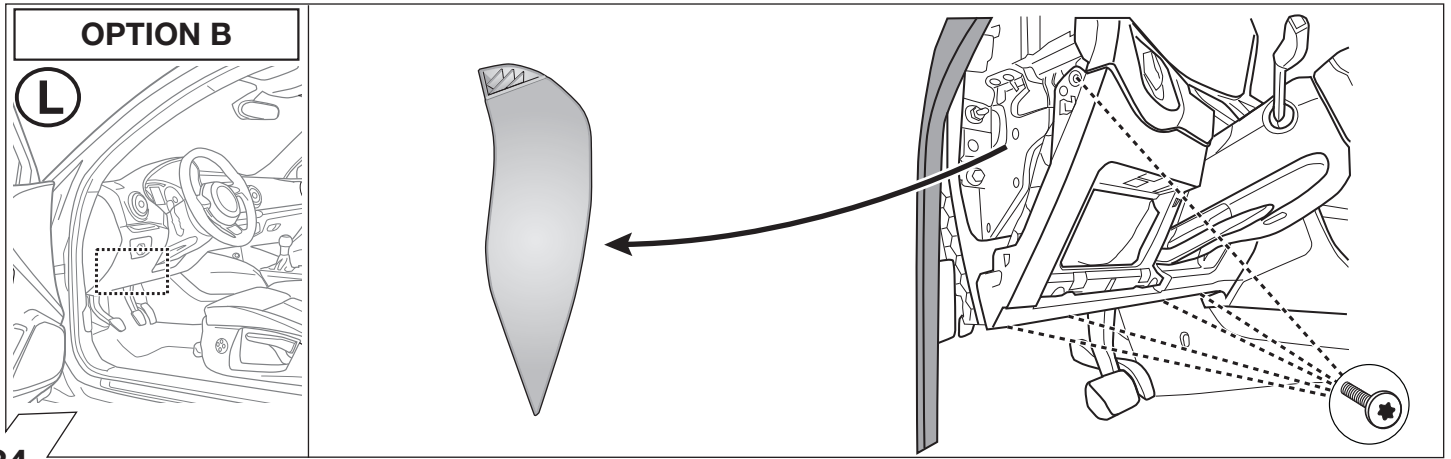
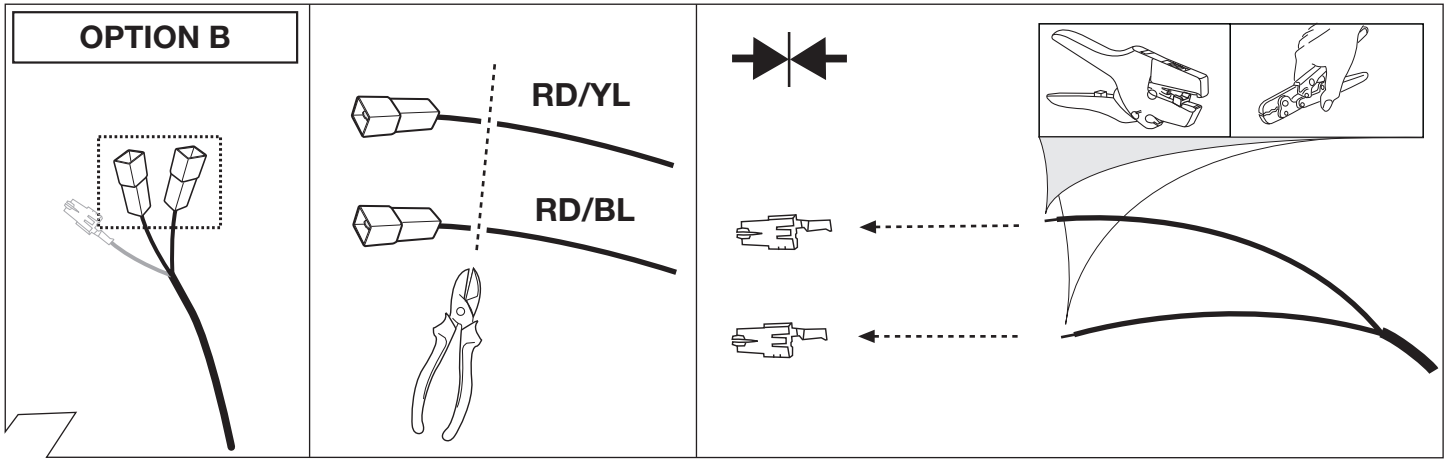

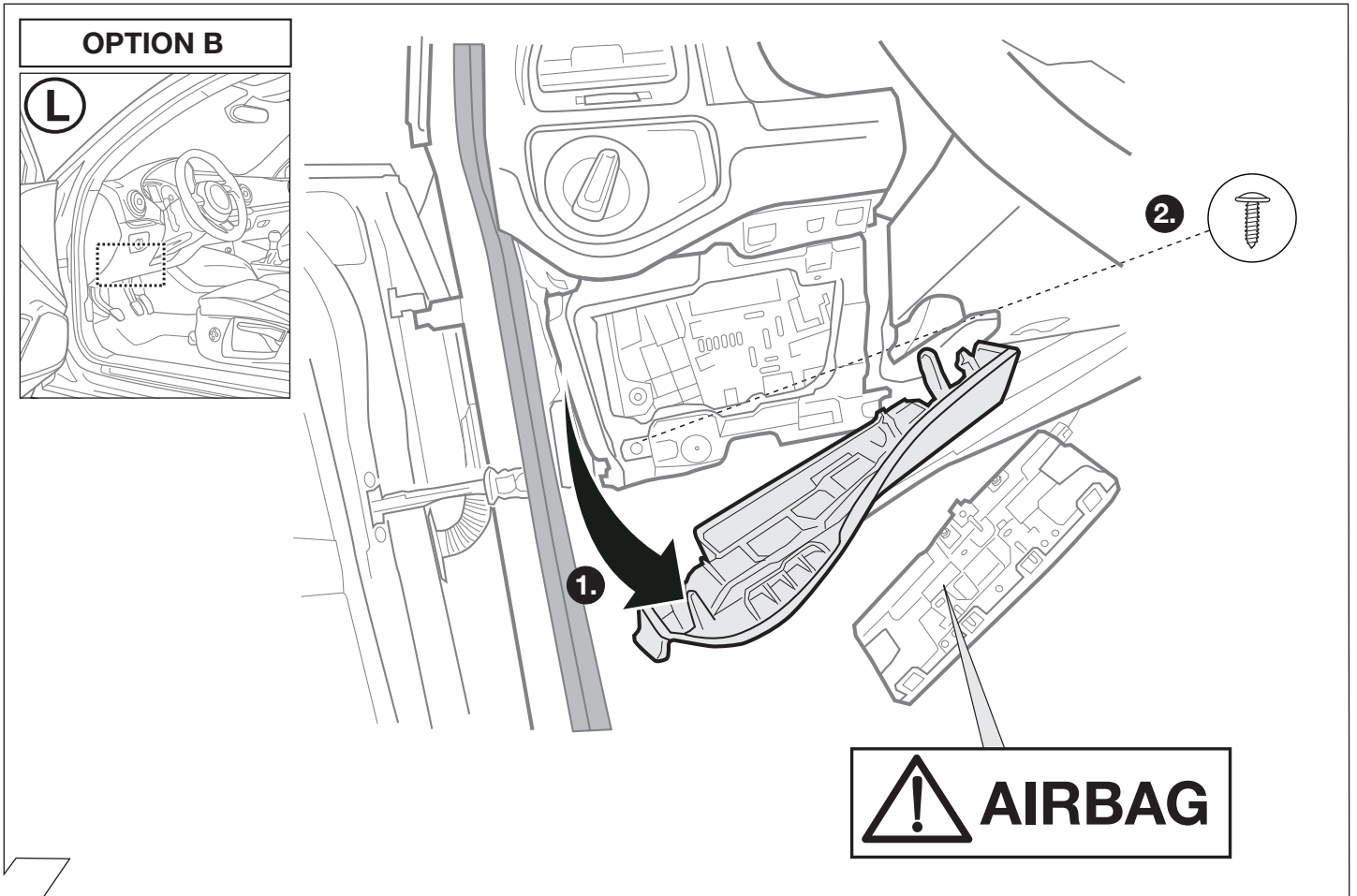

36

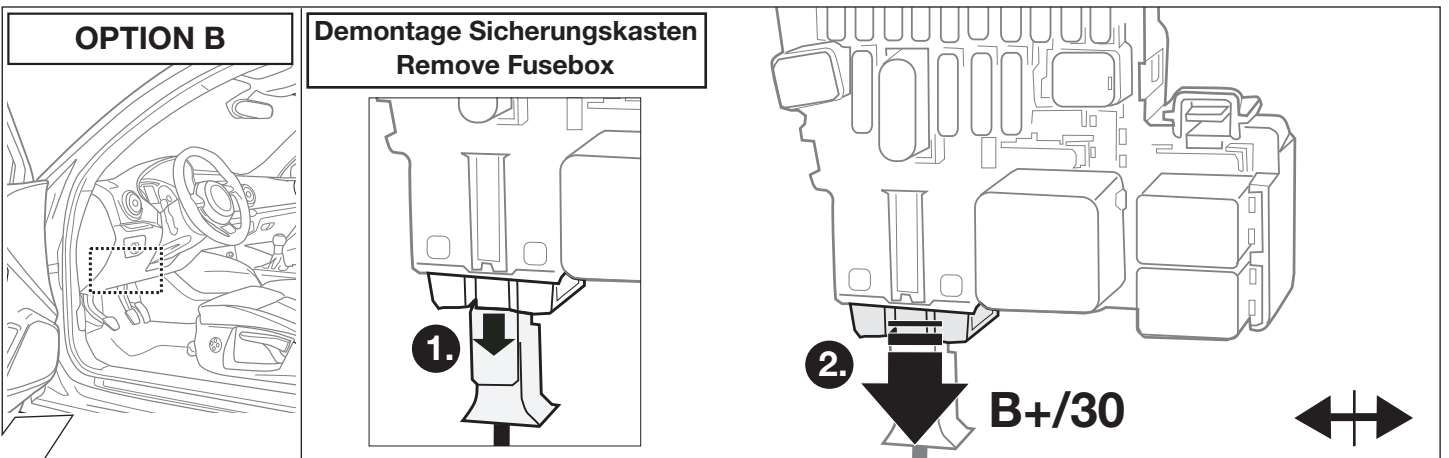

37

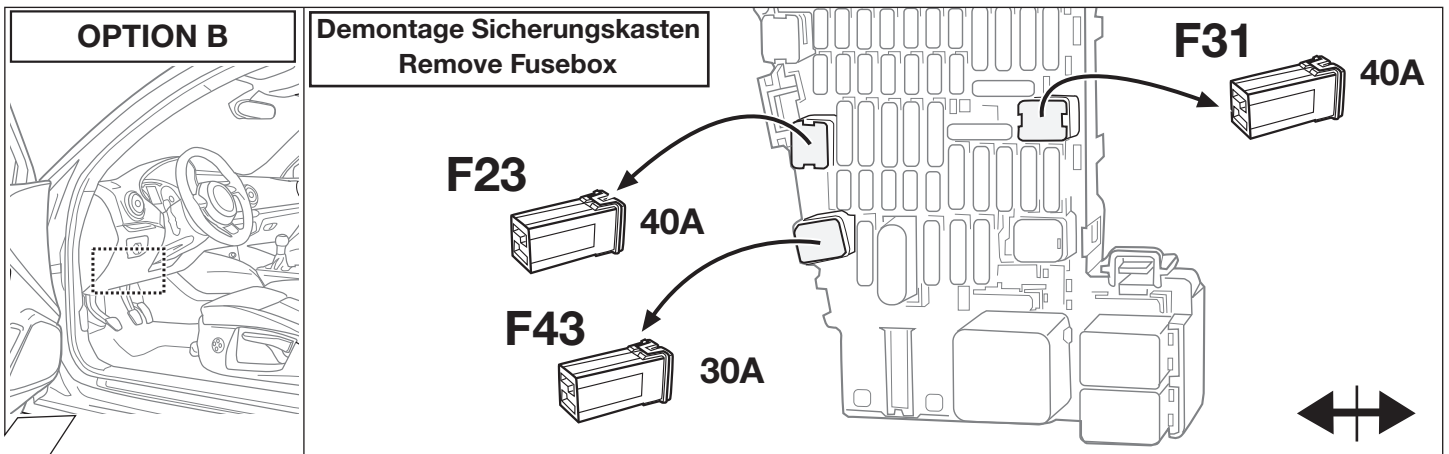

38

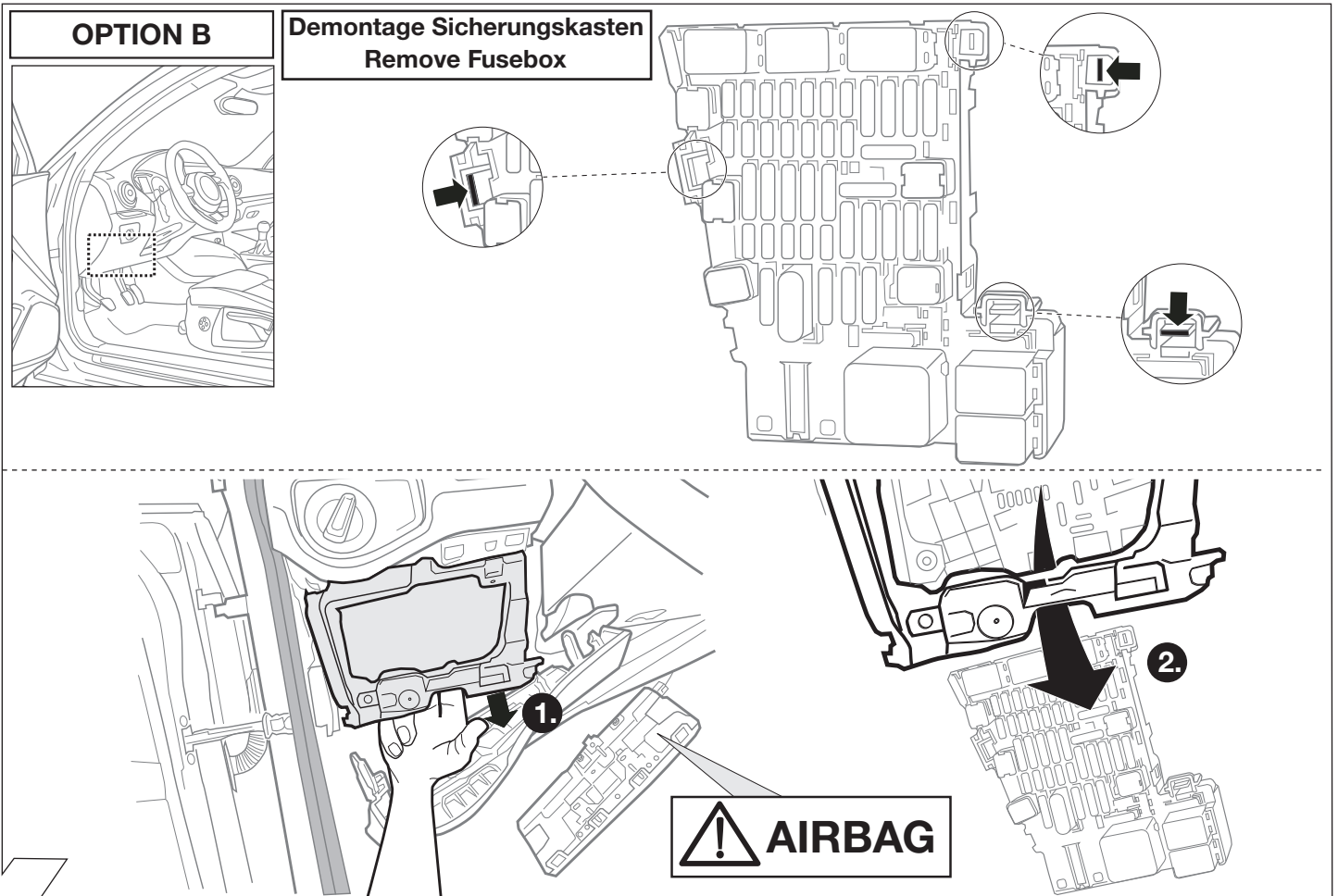

39

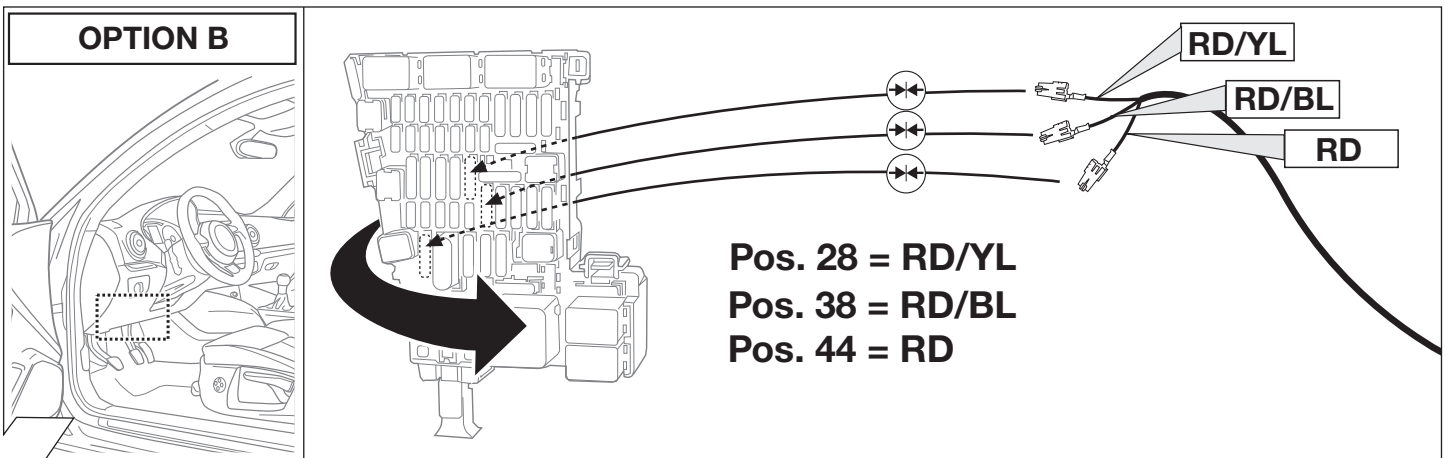

40

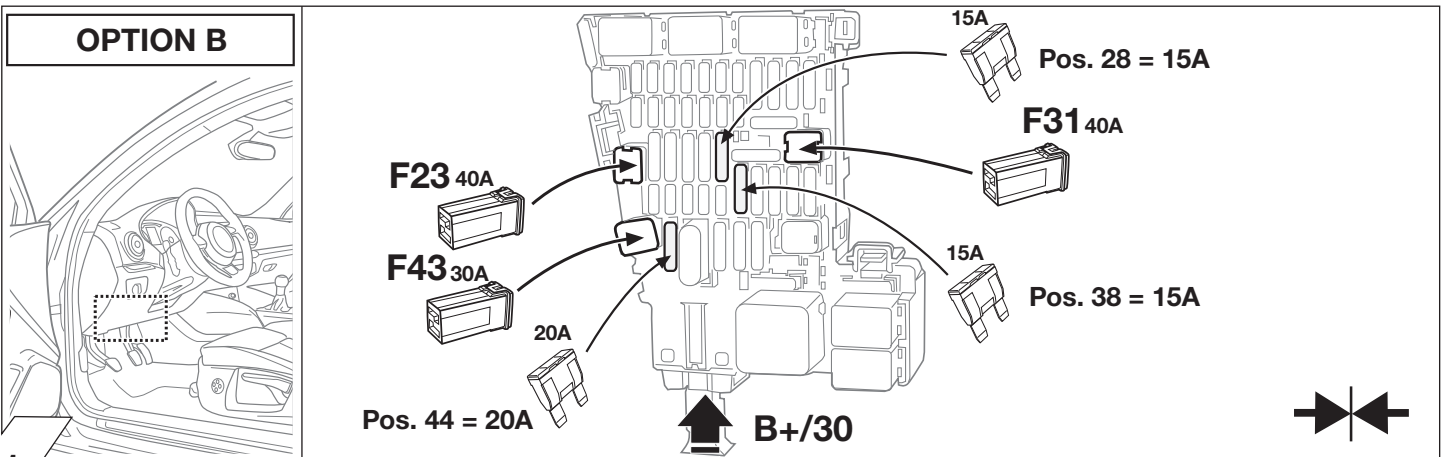

41



**OPTIONAL**

YL/BR RD/BK

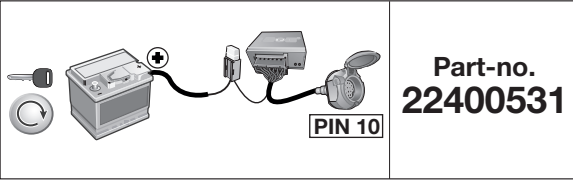
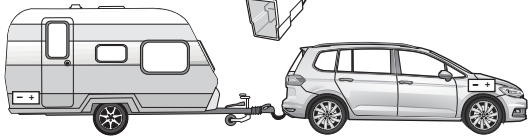

42

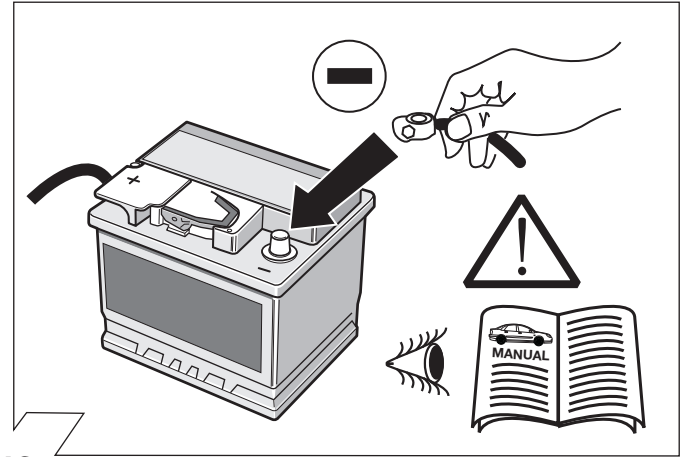

43

**OPTION 1**



**Codierung Steuergerät** Seite 22-24  
**Code Control unit** page 22-24  
**Codage dispositif de commande** page 22-24  
**Codifica dispositivo di controllo** pagina 22-24  
**Contralor de codificacion** pagina 22-24  
**Bedieningsapparaat coderen** pagina 22-24

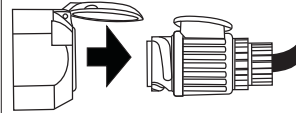
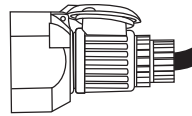
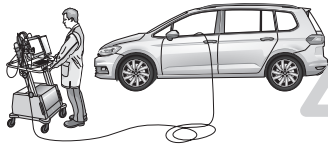

44

**OPTION 2**

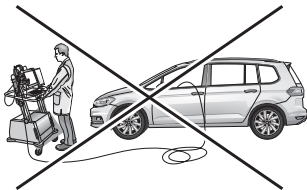

Seite 25  
 page 25  
 page 25  
 pagina 25  
 pagina 25  
 pagina 25

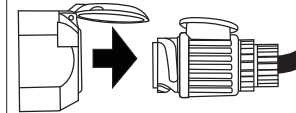
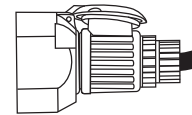



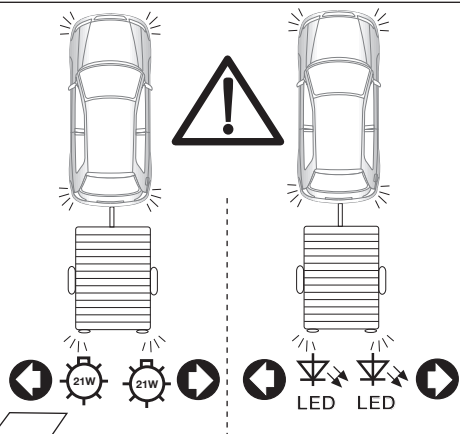

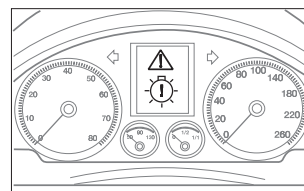

45



LED



46

 <p>Folgende Beleuchtungsfunktionen des Anhängers werden nicht bei allen Zugfahrzeugen mit Tagesfahrlichtschaltung unterstützt:</p> <ul style="list-style-type: none"> <li>• Schlussleuchten</li> <li>• Begrenzungsleuchten</li> <li>• Kennzeichenbeleuchtung</li> </ul> <p>Zur Aktivierung dieser Funktionen muss Stand- oder Abblendlicht eingeschaltet werden!</p>	 <p>Le seguenti funzioni per l'illuminazione del rimorchio non sono supportate da tutte le motrici con circuito di luci diurne:</p> <ul style="list-style-type: none"> <li>• luci posteriori</li> <li>• luci d'ingombro</li> <li>• illuminazione targa</li> </ul> <p>Per attivare queste funzioni devono essere accese le luci di posizione o gli anabbaglianti!</p>
 <p>The following light functions for the trailer are not supported by all towing vehicles with DRL circuit:</p> <ul style="list-style-type: none"> <li>• Rear lights</li> <li>• Side lights</li> <li>• Numberplate lights</li> </ul> <p>The taillights or dimmed headlights must be switched on to activate this function!</p>	 <p>De volgende verlichtingsfuncties van de aanhanger worden niet bij alle trekkende voertuigen met daglichtschakeling ondersteund:</p> <ul style="list-style-type: none"> <li>• Achterlichten</li> <li>• Spatbordlampen</li> <li>• Kentekenverlichting</li> </ul> <p>Ter activering van deze functies moet parkeer- of dimlicht worden ingeschakeld!</p>
 <p>Les fonctions d'éclairage suivantes de la remorque ne sont pas activables sur tous les véhicules de traction équipés de feux de circulation de jour:</p> <ul style="list-style-type: none"> <li>• Feux arrières</li> <li>• Feux d'encombrement</li> <li>• Éclairage de la plaque minéralogique</li> </ul> <p>Pour activer ces fonctions, les feux de position ou de croisement doivent être allumés!</p>	 <p>No todos los vehículos tractores con conmutación de luz de marcha diurna ofrecen un soporte para las siguientes funciones de iluminación del remolque:</p> <ul style="list-style-type: none"> <li>• Luces traseras</li> <li>• Luces de galíbo</li> <li>• Iluminación de la matrícula</li> </ul> <p>¡Para activar estas funciones deberán encenderse las luces de posición o las luces de cruce!</p>

47

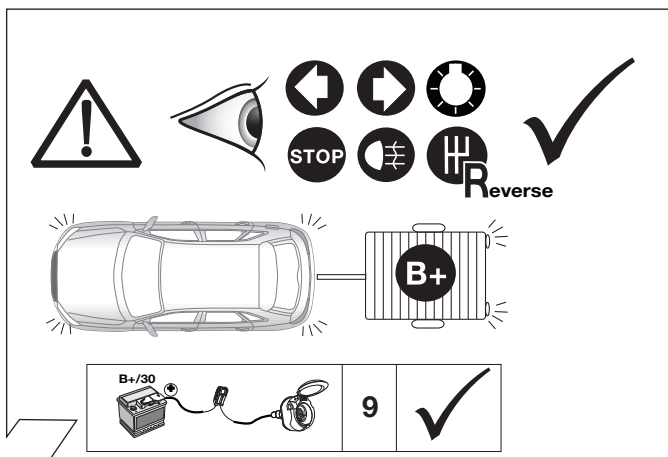

48

**OPTIONAL**

**Trailer Simulator for 7- and 13-pin Sockets**





Part-no. 50400521

49

**50**

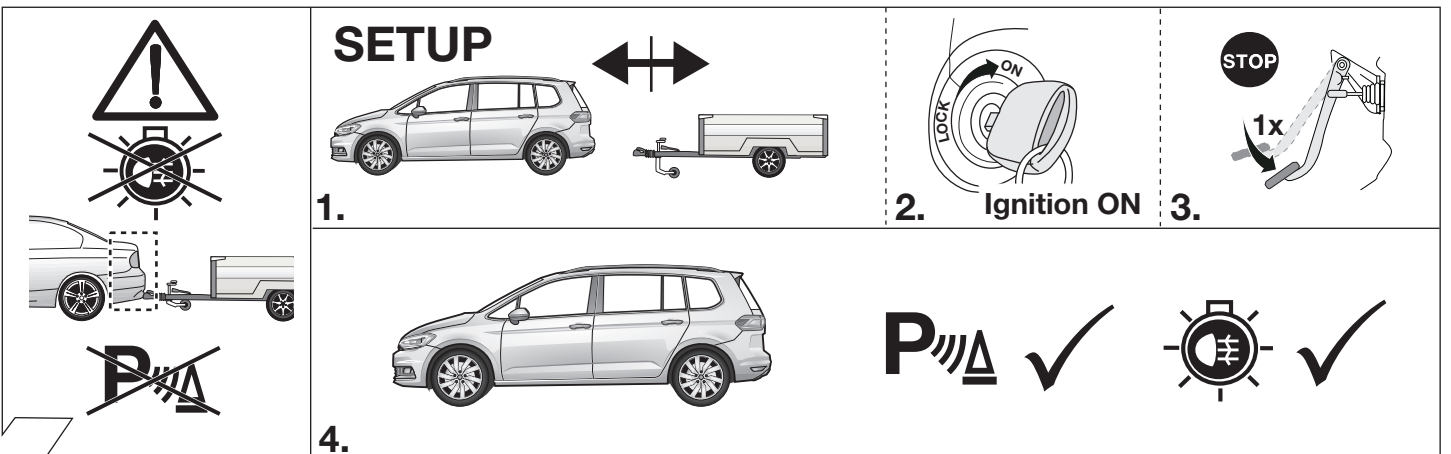
**SETUP**

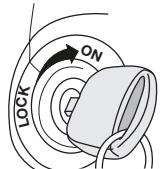

1. 

2.  Ignition ON

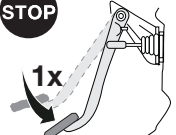
3.  STOP 1x

4. 

**Optional: Adapter socket 62930000**

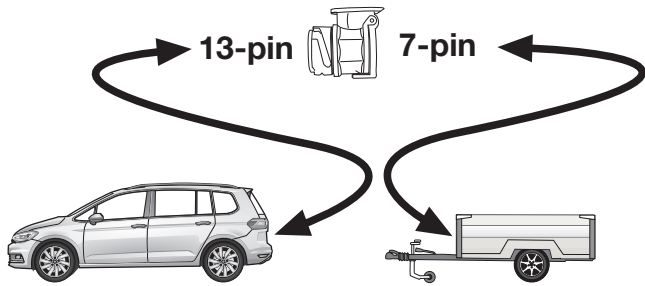

51

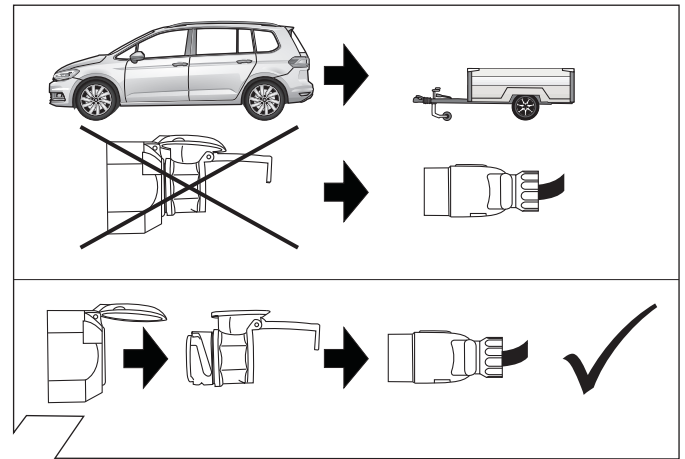

52

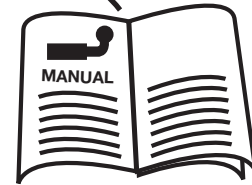
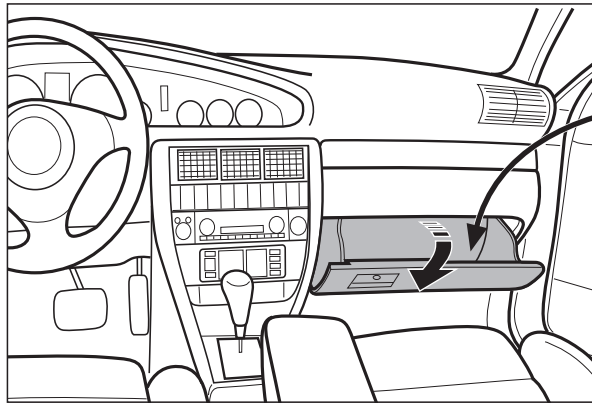

53

**Anhängerbetrieb konfigurieren / Set up trailer operation**

**OPTION 1**

**Aktuellste Version:  
Latest version:**

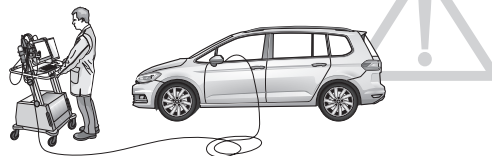

<http://ja-eba.de/c0fa6d7b>

**D**

→ **Diagnosedienstleister bzw. Diagnosemethoden (lokal/offline):**

- Hella Gutmann (→ Seite 22)
- VCDS (→ Seite 23-24)
- VCDS
- Autologic
- Bosch / KTS
- SP Diagnostic
- SUN
- etc. pp.

**GB**

→ **Diagnosis Services or diagnostic methods (local / offline):**

- Hella Gutmann (→ page 22)
- VCDS (→ page 23-24)
- VCDS
- Autologic
- Bosch / KTS
- SP Diagnostic
- SUN
- etc. pp.

**F**

→ **Diagnostic services ou les méthodes de diagnostic (local / hors ligne):**

- Hella Gutmann (→ page 22)
- VCDS (→ page 23-24)
- VCDS
- Autologic
- Bosch / KTS
- SP Diagnostic
- SUN
- etc. pp.

**I**

→ **Diagnosi Servizio o metodi diagnostici (locale / offline):**

- Hella Gutmann (→ pagina 22)
- VCDS (→ pagina 23-24)
- VCDS
- Autologic
- Bosch / KTS
- SP Diagnostic
- SUN
- etc. pp.

**E**

→ **Servicio de Diagnóstico o métodos de diagnóstico (locales / fuera de línea):**

- Hella Gutmann (→ pagina 22)
- VCDS (→ pagina 23-24)
- VCDS
- Autologic
- Bosch / KTS
- SP Diagnostic
- SUN
- etc. pp.

**NL**

→ **Diagnose Dienst of diagnostische methoden (lokale / offline):**

- Hella Gutmann (→ pagina 22)
- VCDS (→ pagina 23-24)
- VCDS
- Autologic
- Bosch / KTS
- SP Diagnostic
- SUN
- etc. pp.

54

## OPTION 1

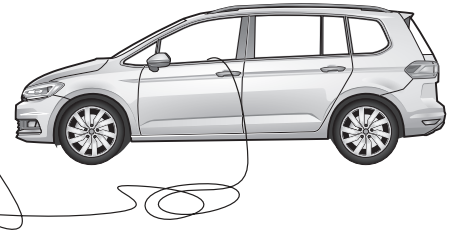
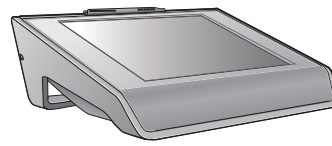

**D**

**Die Aktivierung der Anhängerfunktionen muss wie folgt durchgeführt werden:**

1. Fahrzeugauswahl
2. In Diagnose wechseln - Codierung
3. Anhängerkupplung de-/aktivieren
4. Diagnose Interface Bus auswählen
5. Anleitung folgen

**Fahrzeuge mit Assistenzsystemen**

6. AHK an Assistenzsysteme anpassen ausführen
7. Anleitung folgen

8. Diagnose

9. Fehlerspeicher auslesen, ggf. löschen
10. Fertig

**GB**

**The activation of the trailer functions must be performed as follows:**

1. Vehicle selection
2. switch to diagnostics - coding
3. Deactivate/activate trailer coupling
4. Select diagnostic Interface Bus
5. Follow instructions

**Vehicles with assistance systems**

6. Perform adaptation of trailer coupling on assistance systems
7. Follow instructions

8. Diagnostics

9. Read out error memory, delete if necessary
10. Done

**F**

**Pour activer l'attelage, procéder de la façon suivante :**

1. Choix véhicule
2. Aller dans le diagnostic - codage
3. Activer/désactiver le diagnostic
4. Sélectionner le BUS d'interface de diagnostic
5. Suivre les instructions

**Véhicules avec systèmes d'aide**

6. Effectuer une adaptation d'attelage aux systèmes d'aide
7. Suivre les instructions

8. Diagnostic

9. Lire la mémoire de défaut et effacer les codes d'erreur éventuellement mémorisés
10. Terminé

**I**

**Per attivare le funzioni del rimorchio, procedere nel modo seguente:**

1. Scelta vettura
2. Passare alla >Diagnosi< - Codifica
3. Attivare / disattivare il gancio di traino
4. Selezionare il interfaccia di diagnosi
5. Seguire le istruzioni

**Veicoli con sistemi di assistenza**

6. Adattare i sistemi installati
7. Seguire le istruzioni

8. Diagnosi

9. Leggere la memoria guasti e cancellare, se necessario
10. Terminato

**E**

**La activación de las funciones de remolque debe realizarse de la siguiente manera:**

1. Selección de vehículo
2. Cambiar a diagnosis - Codificación
3. Desactivar/activar acoplamiento para remolque
4. Seleccionar diagnosis Interface Bus
5. Seguir las instrucciones

**En vehículos con sistemas de asistencia**

6. Ejecutar adaptación de acoplamiento para remolque a sistemas de asistencia
7. Seguir las instrucciones

8. Diagnosi

9. Leer memoria de averías y borrarla si es necesario
10. Listo

**NL**

**De activering van de aanhangerfuncties moet als volgt worden uitgevoerd.:**

1. Voertuigselectie
2. Ga naar Diagnose - Codering
3. Aanhangwagenkoppeling deactiveren/activeren
4. Diagnose interface bus selecteren
5. Volg instructie op

**Bij voertuigen met assistentiesystemen**

6. "Aanhangwagenkoppeling aanpassen aan assistentiesystemen" uitvoeren
7. Volg instructie op

8. Diagnose

9. Foutcodegeheugen uitlezen en indien nodig wissen
10. Gereed

## OPTION 1

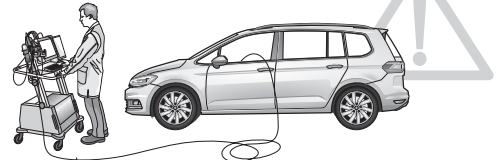

**D**

### Codierung VW/Audi/Seat/Skoda mit VCDS

#### Bitte beachten :

Der nachfolgend beschriebene Ablauf zur Codierung bzw. Freischaltung auf Anhängerbetrieb dient lediglich zur allgemeinen Orientierung und kann je nach Modell (Motorisierung/ Ausstattung) stark variieren. Gegebenenfalls müssen weniger oder noch weitere Steuergeräte angepasst werden.

- **Codierung Gateway\_19 (Diagnoseinterface)**  
Verbauliste ->  
69 Anhänger -> verbaut
- **Codierung EZE\_09 (Elektronisches Zentralelektrik-Steuergerät):**  
Zugriffsberechtigung: 31347  
Anpassung -10  
Anpassungskanal:  
Vernetzung  
Anhängeranschlussgerät -> verbaut  
Trailer Hitch Control Module -> verbaut
- **Codierung DIS\_13 (Distanzregelung)**  
Zugriffsberechtigung: 20103  
Codierung  
Control Module for Trailer -> verbaut
- **Codierung ZKS\_46 (Zentralmodul Komfortsystem)**  
Trailer control unit -> verbaut
- **Codierung SWA\_3C (Spurwechselassistent)**  
Trailer control unit -> verbaut
- **Codierung SCH\_17 (Schalttafeleinsatz)**  
Trailer control unit -> verbaut
- **Codierung RFK\_6C (Rückfahrkamerasystem)**  
Anhängererkennung -> verbaut
- **Codierung STF\_74 (Fahrwerkssteuerung)**  
Anhänger -> verbaut
- **Codierung EPH\_10 (Einparkhilfe Steuergerät)**  
Anhänger -> Anhängervorrichtung manuell abnehmbar
- **Codierung FFF\_A5 (Frontsensorik Steuergerät)**  
Anhängerelektronik -> verbaut
- **Codierung HDE\_6D (Heckdeckelelektronik Steuergerät)**  
Steuergerät für Anhänger -> verbaut

#### Wichtiger Hinweis zur Codierung bzw. Freischaltung auf Anhängerbetrieb.

Die vorab genannten Einstellungen werden im Bordnetz des Fahrzeuges vorgenommen und lokal abgespeichert. Bei generellen Updates der Fahrzeugsoftware (beispielsweise im Rahmen von Service- oder Instandsetzungsarbeiten), können diese Einstellungen unter Umständen wieder überschrieben und gelöscht werden. In diesem Fall muss die Freischaltung auf Anhängerbetrieb nach dem Update noch einmal lokal aktualisiert werden.

**GB**

### Encoding VW/Audi/Seat/Skoda with VCDS

#### Please note :

The procedure described below for encoding and enabling the trailer mode only serves for a general orientation and can vary greatly depending on the model (motorisation / equipment). If necessary, fewer or further control units will have to be adapted.

- **Encoding Gateway\_19**  
Installations List ->  
69 Trailer hitch control module -> installed
- **Encoding EZE\_09 (electronic central electric controller):**  
Access authorisation: 31347  
Adaptation -10  
Adaptation channel:  
networking trailer connection device -> installed  
Trailer hitch control module -> installed
- **Encoding DIS\_13 (distance control)**  
Access authorisation 20103  
Encoding  
Control module for trailer -> installed
- **Encoding ZKS\_46 (central module comfort system)**  
Trailer control unit -> installed
- **Encoding SWA\_3C (lane change assistant)**  
Trailer control unit -> installed
- **Encoding SCH\_17 (control panel insert)**  
Trailer control unit -> installed
- **Encoding RFK\_6C (reversing camera system)**  
Trailer detection -> installed
- **Encoding STF\_74 (chassis control)**  
Trailer -> installed
- **Encoding EPH\_10 (PDC controller)**  
Trailer ->Trailer device  
can be removed manually
- **Encoding FFF\_A5 (front sensor system controller)**  
Trailer electronics -> installed
- **Encoding HDE\_6D (boot lid electronics controller)**  
Controller for trailer -> installed

#### Important note on encoding and activating in trailer mode.

The aforementioned settings are carried out in the vehicle's electrical system and saved locally. During general updates for the vehicle software (for example, within the scope of service or repair work), the settings may be overwritten and deleted under certain circumstances. In this case, the trailer mode activation has to be updated again locally after the update.

**F**

### Codage VW/Audi/Seat/Skoda avec VCDS

#### Attention :

Le déroulement du codage et de l'activation du fonctionnement avec remorque décrit ci-après sert uniquement d'information générale et peut varier fortement d'un modèle à l'autre (motorisation / équipement). Le cas échéant, il faudra ajuster moins ou au contraire plus d'appareils de commande.

- **Codage Gateway\_19**  
Installations List ->  
69 Trailer hitch control module -> monté
- **Codage EZE\_09 (appareil de commande électronique de la centrale électrique):**  
Autorisation d'accès: 31347  
Ajustement -10  
Canal d'ajustement:  
mise en réseau de l'appareil de connexion de la remorque montée  
Trailer Hitch Control Module -> monté
- **Codage DIS\_13 (réglage de la distance)**  
Autorisation d'accès 20103  
Codage  
Control Modul for Trailer -> monté
- **Codage ZKS\_46 (module central système confort)**  
Trailer control unit -> monté
- **Codage SWA\_3C (assistant de changement de file)**  
Trailer control unit -> monté
- **Codage SCH\_17 (porte-instruments)**  
Trailer control unit -> monté
- **Codage RFK\_6C (système de caméra de marche arrière)**  
Identification de la remorque -> montée
- **Codage STF\_74 (commande du châssis)**  
Remorque -> montée
- **Codage EPH\_10 (appareil de commande aide au stationnement)**  
Remorque -> Dispositif de remorque démontable à la main
- **Codage FFF\_A5 (appareil de commande capteurs avant)**  
Électronique de la remorque -> montée
- **Codage HDE\_6D (appareil de commande de l'électronique du hayon)**  
Appareil de commande pour débutants -> monté

#### Remarque importante sur le codage et l'activation du fonctionnement avec remorque.

Les réglages mentionnés ci-dessus sont effectués dans le réseau de bord du véhicule et sauvegardés localement. Pour les mises à jour générales du logiciel du véhicule (par exemple dans le cadre de travaux d'entretien ou de réparation), ces réglages peuvent dans certains cas être écrasés et supprimés. Dans ce cas, l'activation du fonctionnement avec remorque doit être encore une fois actualisée localement après la.



## OPTION 1

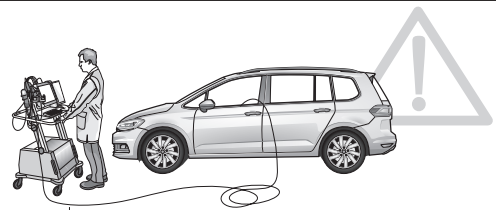

**I**

### Codifica VW/Audi/Seat/Skoda con VCDS

#### Attenzione :

Il procedimento di codifica o abilitazione a esercizio con rimorchio descritto qui di seguito serve esclusivamente come orientamento generale e può variare radicalmente a seconda del modello (motorizzazione/dotazione). È possibile che alcune o ancora altre centraline debbano essere adeguate.

- **Codifica Gateway\_19**  
Installations List ->  
Trailer hitch control module -> installato
- **Codifica EZE\_09 (centralina del sistema elettrico centrale elettronico):**  
Autorizzazione all'accesso: 31347  
Adeguamento -10  
Canale di adeguamento:  
collegamento apparecchio a rimorchio installato  
Trailer Hitch Control Module -> installato
- **Codifica DIS\_13 (regolazione distanza)**  
Autorizzazione all'accesso 20103  
Codifica  
Control Modul for Trailer -> installato
- **Codifica ZKS\_46 (modulo centrale sistema comfort)**  
Trailer control unit -> installato
- **Codifica SWA\_3C (assistente cambio di corsia)**  
Trailer control unit -> installato
- **Codifica SCH\_17 (quadro strumenti)**  
Trailer control unit -> installato
- **Codifica RFK\_6C (telecamera retromarcia)**  
Riconoscimento rimorchio -> installato
- **Codifica STF\_74 (sistema di controllo del telaio)**  
Rimorchio -> installato
- **Codifica EPH\_10 (centralina ausilio di parcheggio)**  
Rimorchio dispositivo rimorchio  
rimovibile manualmente
- **Codifica FFF\_A5 (centralina sensori frontali)**  
Sistema elettronico rimorchio -> installato
- **Codifica HDE\_6D (centralina sistema elettronico portellone portabagagli)**  
Centralina per rimorchio + installata

#### Avvertenza importante per la codifica o l'attivazione per funzionamento con rimorchio.

Le impostazioni indicate in precedenza vengono effettuate nella rete di bordo del veicolo e memorizzate localmente. Nel caso di update generali del software del veicolo (ad esempio nell'ambito di lavori di assistenza o messa a punto) in particolari circostanze è possibile sovrascrivere e cancellare nuovamente queste impostazioni. In questo caso dopo l'update l'attivazione per funzionamento con rimorchio deve essere aggiornata di nuovo localmente.

**E**

### Codificación VW/Audi/Seat/Skoda con VCDS

#### Atención :

El proceso de codificación y/o habilitación descrito a continuación es una mera orientación general y puede variar considerablemente en función del modelo (motorización / equipamiento). Según el caso será necesario adaptar un mayor o menor número de unidades de control.

- **Encoding Gateway\_19**  
Installations List ->  
Trailer hitch control module -> montado
- **Codificación EZE\_09** (unidad de control electrónica del sistema eléctrico central):  
Autorización de acceso: 31347  
Adaptación -10  
Canal de adaptación:  
Interconexión unidad de control de remolque montada  
Trailer Hitch Control Module -> montado
- **Codificación DIS\_13** (regulación de distancia)  
Autorización de acceso 20103  
Codificación  
Control Modul for Trailer -> montado
- **Codificación ZKS\_46** (módulo central del sistema de confort)  
Trailer control unit -> montada
- **Codificación SWA\_3C** (asistente de cambio de carril)  
Trailer control unit -> montada
- **Codificación SCH\_17** (utilización del cuadro de distribución)  
Trailer control unit -> montada
- **Codificación RFK\_6C** (sistema de cámaras de marcha atrás)  
Identificación de remolque -> montada
- **Codificación STF\_74** (control de chasis)  
Remolque -> montado
- **Codificación EPH\_10** (unidad de control del sistema de ayuda al aparcamiento)  
Remolque -> Dispositivo de remolque desmontable a mano
- **Codificación FFF\_A5** (unidad de control del sistema de sensores frontales)  
Sistema electrónico de remolque -> montado
- **Codificación HDE-6D** (unidad de control del sistema electrónico de la puerta del maletero):  
Unidad de control para remolque -> montada

#### Nota importante sobre la codificación y/o habilitación del modo remolque.

Los ajustes anteriormente mencionados se llevan a cabo en el sistema eléctrico de a bordo y se guardan de forma local. En caso de actualizaciones generales (por ejemplo, con motivo de trabajos de mantenimiento o reparación), puede que se vuelvan a sobrescribir y borrar estos ajustes. En tal caso se debe volver a actualizar la habilitación del modo remolque de forma local después de la actualización.

**NL**

### Codering VW/Audi/Seat/Skoda met VCDS

#### Gelieve in acht nemen :

De hierna beschreven procedure voor de codering resp. vrijgave voor het gebruik met aanhangwagen dient louter voor een algemene oriëntatie en kan, afhankelijk van het model (motorisering / uitrusting), sterk variëren. Eventueel moet er minder of nog andere bedieningsapparaten aangepast worden.

- **Codering Gateway 19**  
Installations List ->  
Trailer hitch control module -> ingebouwd
- **Codering EZE\_09 (elektronisch bedieningsapparaat "Centrale elektriciteit"):**  
Toegangsbevoegdheid: 31347  
Aanpassing -10  
Aanpassingskanaal:  
Koppeling aansluitapparaat aanhangwagen ingebouwd  
Trailer Hitch Control Module -> ingebouwd
- **Codering DIS\_13 (afstandsregeling)**  
Toegangsbevoegdheid 20103  
Codering  
Control Modul for Trailer -> ingebouwd
- **Codering ZKS\_46 (centrale module comfortsysteem)**  
Trailer control unit -> ingebouwd
- **Codering SWA\_3C (spoorwisselassistent)**  
Trailer control unit -> ingebouwd
- **Codering SCH\_17 (gebruik schakelpaneel)**  
Trailer control unit -> ingebouwd
- **Codering RFK\_6C (terugrijd-camerasysteem)**  
Detectie aanhangwagen -> ingebouwd
- **Codering STF\_74 (chassisbesturing)**  
Aanhangwagen -> ingebouwd
- **Codering EPH\_10 (parkeerhulp bedieningsapparaat)**  
Aanhangwagen Aanhangerinrichting  
handmatig afneembaar
- **Codering FFF\_A5 (frontale sensoriek bedieningsapparaat)**  
Elektronica aanhangwagen -> ingebouwd
- **Codering HDE\_6D (elektronica achterdek bedieningsapparaat)**  
Bedieningsapparaat voor  
aanhangwagen + ingebouwd

#### Belangrijke aanwijzing voor codering resp. vrijgave voor gebruik met aanhangwagen.

De vooraf vermelde instellingen worden in het boordnet van het voertuig doorgevoerd en lokaal opgeslagen. Bij algemene updates van de voertuigsoftware (bijvoorbeeld in het kader van service- of instandhoudingswerkzaamheden) kunnen deze instellingen soms weer overschreven en gewist worden. In dit geval moet de vrijgave voor het gebruik met aanhangwagen na de update nogmaals lokaal geactualiseerd worden.

OPTION 2



58

OPTION 2

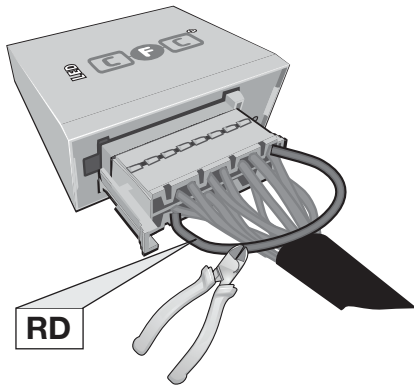

Pin 11 and Pin 2 disconnected  
Pin 11 and Pin 2 unterbrochen

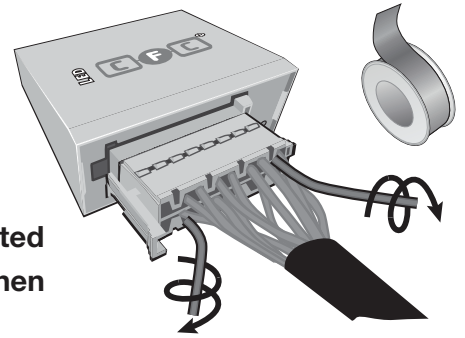

59

OPTION 2

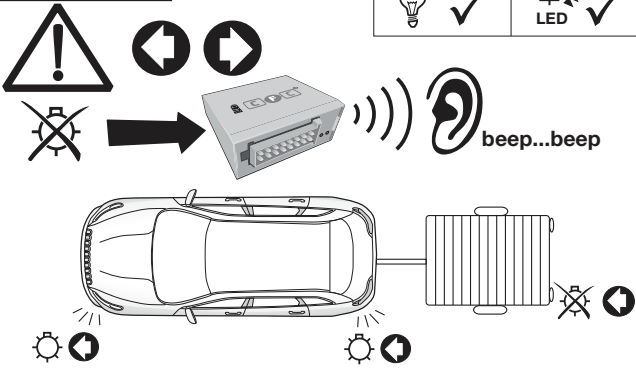

60

OPTION 2

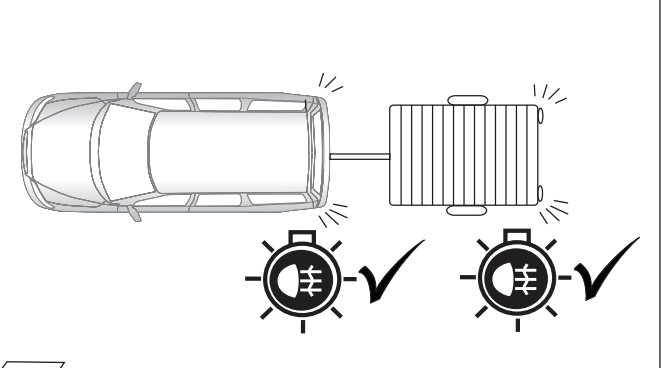

61

OPTION 2

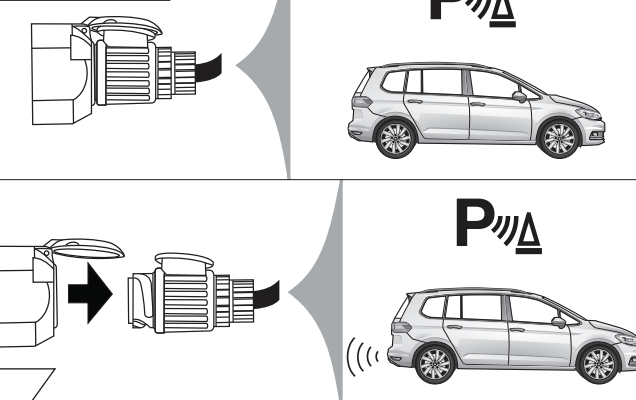

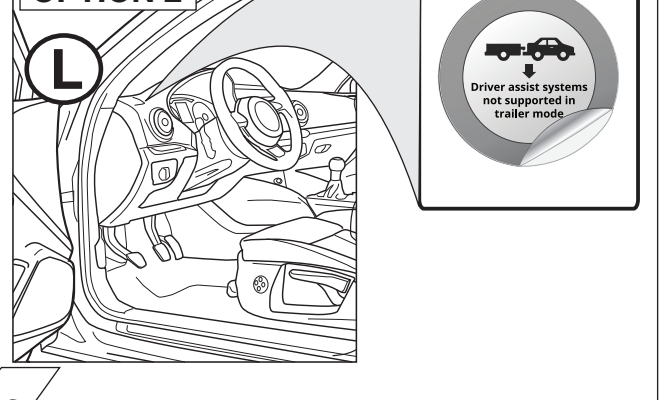

62

OPTION 2

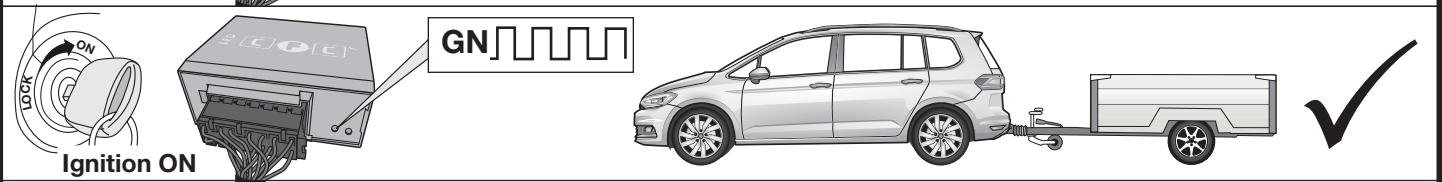
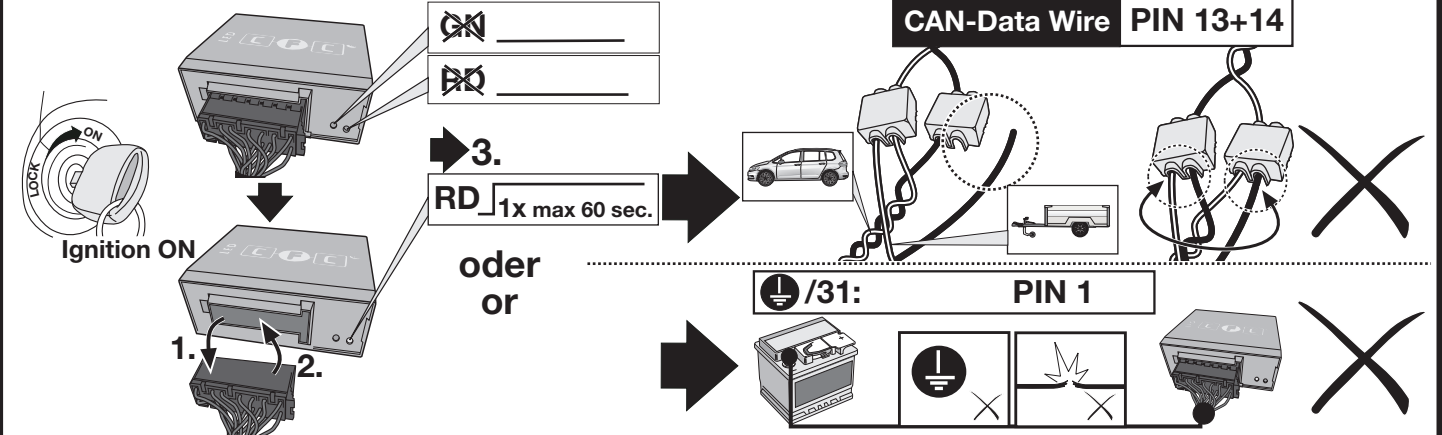
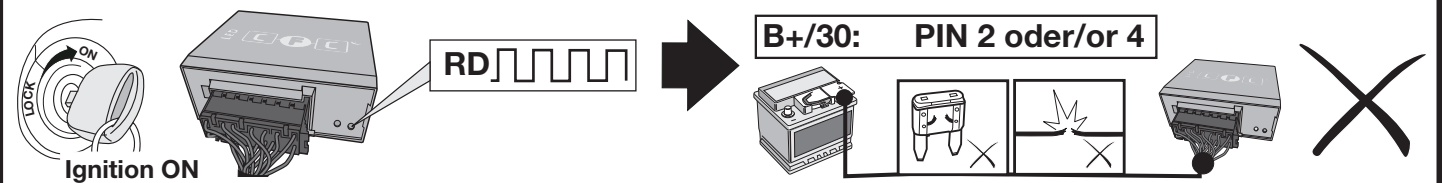

63

<b>D</b> Diagnosefunktion der Kontroll-LED's	<b>GB</b> Diagnosis function of control LEDs	<b>F</b> Fonction diagnostic des LED de contrôle
<b>I</b> Funzione di diagnostica dei LED di controllo	<b>E</b> Función de diagnóstico de los LEDs de control	<b>NL</b> Diagnosefunctie van de controle-LED's
		
		
		
		
		
<p><b>D</b> Blinküberwachung und Leuchten-Substitution bei Ausfall der Anhänger-Blinkleuchten</p> <p>Der Ausfall von einer oder von beiden Anhänger-Blinkleuchten wird je nach Fahrzeugtyp und Ausführung des verbauten Elektro-Einbausatzes wie folgt angezeigt:</p> <ul style="list-style-type: none"> <li>• Erhöhung / Verdoppelung der Blinkfrequenz</li> <li>• Volltextmeldung im Display / Kombi-Instrument</li> <li>• Aktivierung Kontrollleuchte für Lampenausfall</li> <li>• Akustische Warnung via Buzzer oder Voice-Message</li> </ul> <p>Bei einem Blinkleuchten-Ausfall ersetzt die gleichseitige Rückleuchte durch Aufleuchten in der Blinkfrequenz eine defekte Anhänger-Blinkleuchte (Leuchten-Substitution!).</p>	<p><b>GB</b> Indicator failure detection and lamp substitution if the trailer indicators fail</p> <p>The failure of a single or on both trailer indicators will be shown depending on the type of vehicle and electric kit installed as follows:</p> <ul style="list-style-type: none"> <li>• Increase in the flashing frequency</li> <li>• Text message in the Display / combi-instrument</li> <li>• Activated control lamp for light failure</li> <li>• Audible warning via Buzzer or Voice-Message</li> </ul> <p>If an indicator fails the left or right rear light compensates the faulty indicator by flashing at the correct frequency! (Lamp substitution).</p>	
<p><b>F</b> Surveillance des clignotants et substitution des feux en cas de panne des clignotants de la remorque</p> <p>La panne d'un ou des deux clignotants de la remorque est indiquée de la façon suivante en fonction du type de véhicule et du modèle de module électrique monté:</p> <ul style="list-style-type: none"> <li>• Augmentation / doublement de la fréquence de clignotement</li> <li>• Message complet sur l'affichage / l'instrument combiné</li> <li>• Activation du voyant de contrôle pour panne de lampe</li> <li>• Avertissement sonore via buzzer ou message vocal</li> </ul> <p>En cas de panne du clignotant, le feu arrière du côté de la panne remplace un clignotant de remorque défectueux en s'allumant à la même fréquence que le clignotant! (Substitution des feux!).</p>	<p><b>I</b> Controllo delle frecce e sostituzione delle lampade in caso di guasto alle frecce del rimorchio</p> <p>A seconda del tipo di veicolo e della versione del kit elettrico montato, il guasto di una o di entrambe le frecce del rimorchio si manifesta come segue:</p> <ul style="list-style-type: none"> <li>• Aumento/raddoppio della frequenza di lampeggiamento</li> <li>• Full text display / strumento combinato</li> <li>• Attivazione della spia di controllo per il guasto lampada</li> <li>• Segnalazione acustica mediante cicalino o messaggio vocale</li> </ul> <p>In caso di guasto alla luce della freccia, la luce posteriore dello stesso lato si accende sostituendo nella frequenza del lampeggio la freccia difettosa del rimorchio. (Sostituzione delle lampade!).</p>	
<p><b>E</b> Control de intermitentes y sustitución de lámparas en caso de fallo de los intermitentes del remolque</p> <p>El fallo de uno o de ambos intermitentes del remolque se indicará de la siguiente manera en función del tipo del vehículo y de la ejecución del juego de montaje eléctrico montado:</p> <ul style="list-style-type: none"> <li>• Aumento/duplicación de la frecuencia de parpadeo</li> <li>• Mensaje de texto completo en el display/instrumento combinado</li> <li>• Activación de la lámpara piloto para el fallo de lámparas</li> <li>• Advertencia acústica mediante zumbador o mensaje de voz</li> </ul> <p>Si hay un fallo de intermitente, la luz trasera del mismo lado reemplazará a la lámpara defectuosa del intermitente parpadeando en la misma frecuencia que el intermitente (Substitución de lámparas!).</p>	<p><b>NL</b> Knippercontrole en lampvervanging bij uitval van de knipperlampen van een aanhangwagen</p> <p>De uitval van één of beide knipperlampen van een aanhangwagen wordt afhankelijk van het voertuigtype en de uitvoering van de ingebouwde elektroset als volgt aangegeven:</p> <ul style="list-style-type: none"> <li>• Verhoging / verdubbeling van de knipperfrequentie</li> <li>• Volledige tekstweergave op het display / combi-instrument</li> <li>• Activering controlelampje voor uitval van een lamp</li> <li>• Akoestische waarschuwing via buzzer of Voice-Message</li> </ul> <p>Bij een uitval van (een) knipperlamp(en) vervangt het gelijkzijdige achterlicht door aan te flitsen bij de knipperfrequentie een defecte knipperlamp van een aanhangwagen (Lampvervanging!).</p>	

ERKLÄRUNG SYMBOLE	SYMBOL EXPLANATION	EXPLICATION DES SYMBOLES	SPIEGAZIONE DEI SIMBOLI	EXPLICACIÓN DE LOS SIMBOLES	VERKLARING SYMBOLEN
(D)	(GB)	(F)	(I)	(E)	(NL)
	left (58-L) respectively right (58-R) tail light	feu arrière gauche (58-L) respectivement droite (58-R)	luce posteriore sinistra (58-L) rispettivamente destra (58-R)	plato trasero izquierdo (58-L) respectivamente derecho (58-R)	Linker (58-L) c.d. rechter (58-R) achterlicht
	stop light (54) / high mounted, third stop light (54)	feu de stop (54) / 3ième feu de stop (54)	luce d'arresto (54) / 3. luce d'arresto (54)	luz de freno (54) / tercera luz de freno (54)	Remlicht (54) / 3e remlicht (54)
	turn signal indicator left	feu indicateur de direction gauche	indicatore di direzione sinistra	luz indicadora de dirección de marcha izquierda	Richtingaanwijzer links
	turn signal indicator right	feu indicateur de direction droite	indicatore di direzione destra	luz indicadora de dirección de marcha derecha	Richtingaanwijzer rechts
	rear fog light(s)	feu (x) arrière (s) de brouillard	fendinebbia	luz (-ces) trasera (s) antineblia (s)	Mistachterlicht(en)
	reversing light(s)	feu (x) de marche arrière	luce (l) retromarcia	luz (-ces) de marcha atrás	Achteruitrijlicht(en)
	Permanent power supply / 13pin socket, chamber 9	courant continue / prise de courant à 13 pôles, compartiment 9	alimentazione continua / presa 13 poli, camera 9	positivo continuo / caja de anclaje a 13 polos, cámara 9	Continuustroom / stekkerdoos 13P kamer 9
	charging wire for trailer battery / 13pin socket, chamber 10	cable de charge / prise de courant à 13 pôles, compartiment 10	cavo di carica / presa 13 poli, camera 10	cable de carga / caja de anclaje a 13 polos, cámara 10	Laaddraad / stekkerdoos 13P kamer 10
	trailer / trailer recognition	remorque / détection de la fonction "remorque"	rimorchio / riconoscimento rimorchio	remolque / detección del remolque	Aanhanger / aanhangertentificatie
	Permanent current power supply	courant continue / alimentation électrique permanente	corrente / alimentazione continua	positivo continuo / alimentación de corriente permanente	Continuustroom / permanente stroomvoorziening
	Ground or Earth (31)	masse (31)	masa (31)	masa (31)	Massa (31)
	ground connection battery terminal lug	borne "moins" de la batterie	connessione negativa della batteria	conexión negativa de batería	Accuopoolkleem aansluiting min
	positive connection battery terminal lug	borne "plus" de la batterie	connessione positiva della batteria	conexión positiva de batería	Accuopoolkleem aansluiting plus
	fuse / fuse capacity 20 Ampère	ampérage 20 ampères	fusibile / fusibile con capacity 20 Ampère	fusible / amperaje 20 amperes	Zekering / zekeringsterkte 20 Ampère
	cigarette lighter / accessory socket	allume-cigare / prise d'accessoires	accendisigari / presa accessori	encendido de cigarrillos / caja de accesorios	Sigarettenaansteker / accessoires stekkerdoos
	loudspeaker / buzzer	haut-parleur / vibreur	altoparlante / cicalino	altavoz / señal acústica de advertencia	Luidspreker / waarschuwingsoemer
	park distance control	assistance au parking	sensori di parcheggio	ayuda para aparcar	Inparkeerhulp
	switch / source of function	interrupteur / origine de fonction	interruttore / origine funzione	interruptor / origen de función	Schakelaar / functieoorsprong
	Connect together	raccorder	connessione	conectar	Koppelen
	disconnect	séparer	sconnessione	separar	Ontkoppelen
	Look at / see further information	considérer / voir informations ultérieures	considerare / vedere ulteriori informazioni	considerar / véase las informaciones	Let op / bekijk verdere informatie
	look carefully at selected area	faire attention à la zone sélectionnée	considerare area selezionata	considerar el área seleccionada	Let op gekozen bereik
	Present / Occupied / OK	disponible / occupé / OK	presente / occupato / OK	presente / ocupado / OK	Aanwezig / bezet / i.o.
	Not present / not OK	pas disponible / pas OK	non presente / non OK	non presente / non ocupado / non OK	Niet aanwezig / niet bezet / niet i.o.
	left	gauche	sinistra	izquierdo	Links
	right	droite	destra	derecho	Rechts
	acoustic indication	signalisation acoustique	segnalazione acustica	señalización acústica	Akoestische signalering
	attention / important advice	attention / indication importante	attenzione / indicazione importante	atención / indicación importante	Attentie / belangrijke instructie