

C4 Picasso

06/13 →

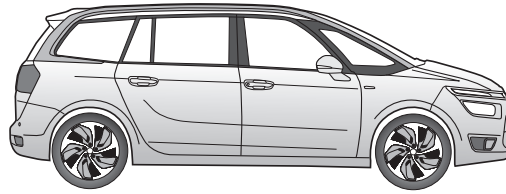

Grand C4 Picasso 10/13 →



Elektro-Einbausatz für Anhängerkupplung / 13-polig / 12 Volt / ISO 11446

## Einbauanleitung



Electric wiring kit for towbars / 13-pin / 12 Volt / ISO 11446

## Fitting instructions



Faisceau pour attelage / 13 broches / 12 Volt / ISO 11446

## Instructions de montage



Cablaggio elettrico per ganci di traino / 13 poli / 12 Volt / ISO 11446

## Istruzione di montaggio



Kits eléctricos para enganches de remolques / 13 pins / 12 Volt / ISO 11446

## Instrucciones de montaje



Elektro-inbouwset voor aanhangerkoppeling / 13-polig / 12 Volt / ISO 11446

## Montagehandleiding

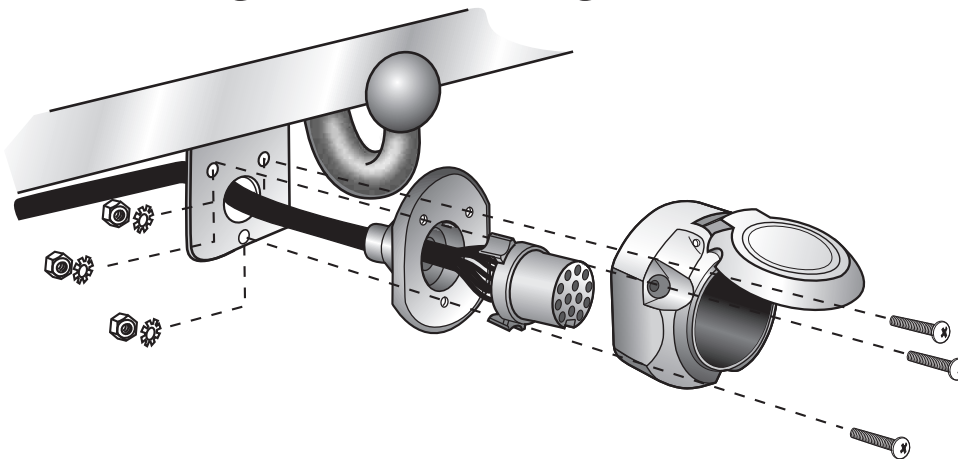

### Anhängerbetrieb konfigurieren / Set up trailer operation

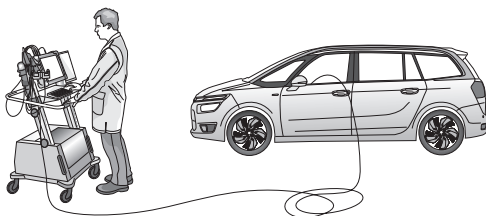

Die Beleuchtungsfunktionen am Anhänger funktionieren nur **NACH** Konfiguration des Fahrzeuges auf Anhängerbetrieb!

The light functions on the trailer will only operate **AFTER** the vehicle has been re-coded!

**WICHTIG!**

Der Einbau dieses Elektrosatzes muß von einer Fachwerkstatt oder einer entsprechend qualifizierten Person durchgeführt werden. Vor Beginn aller Montagearbeiten unbedingt die Einbauanleitung komplett durchlesen. Nach Einbau des Elektrosatzes ist die Einbauanleitung den Serviceunterlagen des Fahrzeuges beizulegen!

Bei unsachgemäßer Anwendung oder Veränderung des Elektrosatzes bzw. der darin befindlichen Bauteile erlischt jeder Anspruch auf Gewährleistung. Beim Fahren ohne Anhänger oder Ladungsträger müssen ggf. verwendete Adapter immer aus der Steckdose entfernt werden. Änderungen bezüglich Konstruktion, Ausstattung, Farbe sowie Irrtum vorbehalten. Alle Angaben und Abbildungen unverbindlich.

Bei Anhängern ohne Nebelschlussleuchte sollte diese nachgerüstet werden.

Für technische bzw. elektronische Änderungen, welche nach erstmaliger Inbetriebnahme des Elektrosatzes vom Fahrzeughersteller durchgeführt werden und beispielsweise zu Fehlfunktionen der Anhängersteckdose oder deren Peripherie führen, übernehmen wir keinerlei Gewährleistung!

Das Anhängermodul ist nicht diagnosefähig! Sollten herstellerseitige Diagnoseprozesse bzw. softwaregestützte Prüfmechanismen Fehlerprotokolle generieren, welche direkt oder indirekt mit Anhängerbetrieb in Zusammenhang stehen, ist das Anhängermodul vom Leitungssatz für die Anhängersteckdose zu trennen und ein nochmaliger Diagnosevorgang zu starten!

**IMPORTANT!**

Installation of the towing electrics kit must be undertaken by a specialist workshop or an appropriately qualified person. Before starting work, you must read the installation instructions through completely. After installing the towing electrics kit, the installation instructions should be kept with the vehicle service documentation.

All claims under the guarantee will lapse in case of improper use or modification of the towing electrics kit or any of its component parts. When driving without a trailer or load carrier, any adapter installed must be removed from the electrical socket. We reserve the right to alter the design, content or colour. We accept no liability for any errors in these instructions. All details and illustrations are non-binding.

In case of missing a rear fog lamp on the trailer, it should be retrofitted.

We accept no responsibility and give no guarantee for technical and electrical modifications made after the initial operation of the towing electrics kit by the vehicle manufacturer and which may lead, for example to malfunction of the trailer socket or its peripheries.

The trailer module is not diagnostics-capable. If the manufacturer's diagnostics processes or software-supported test mechanisms generate error reports directly or indirectly linked with trailer operation, the trailer module must be disconnected from the leads to the trailer socket and a new diagnostic process initiated.

**IMPORTANT!**

Le montage du faisceau doit être effectué par un atelier spécialisé ou par une personne qualifiée en la matière. Avant le début des travaux, lire impérativement les instructions de montage dans leur intégralité. Après le montage du faisceau, joindre les instructions de montage aux documents du véhicule.

Un usage inapproprié ou des modifications du faisceau, ou des pièces qui le composent, entraînent l'expiration de tout droit à la garantie. Lors d'une conduite sans remorque ou porteur de charge, les adaptateurs utilisés doivent, le cas échéant, toujours être enlevés de la prise de courant. Sous réserve de modifications de constructions, équipement, couleurs ou erreur. Données et illustrations sous toute réserve.

Si la remorque n'est pas équipée de feux anti-brouillard arrière, il devra être posé ultérieurement.

Nous n'assumons aucune responsabilité ni garantie pour les modifications techniques et électroniques ayant été effectuées après la première mise en service du kit de connexion électrique par le constructeur automobile et ayant mené par exemple à des mauvais fonctionnements de la prise de remorque ou de sa périphérie.

Le module remorque ne contient pas de fonction diagnostic! Au cas où des processus de diagnostic définis par le fabricant ou des mécanismes de contrôle assistés par ordinateur devaient générer des messages d'erreur directement ou indirectement en rapport avec le fonctionnement de la remorque, il est impératif pour la prise de remorque de détacher le module remorque du groupe électrique et d'initier une nouvelle procédure de diagnostic.

**IMPORTANT!**

L'installazione del kit elettrico deve essere effettuata da un'officina o da personale specializzato. Prima di iniziare tutti i lavori di montaggio, leggere da cima a fondo le istruzioni. Dopo aver installato il kit elettrico si prega di allegare le istruzioni di montaggio ai documenti di manutenzione del veicolo!

In caso di uso improprio o di modifiche del kit elettrico e delle componenti del medesimo, ogni diritto di garanzia decade. Durante la guida senza rimorchio o portacarichi, togliere sempre gli adattatori dalla presa di corrente. Con riserva di modifiche relative a costruzione, equipaggiamento, colore e salvo errori. Tutte le indicazioni e illustrazioni non sono vincolanti.

In caso di rimorchi non corredati di luce retronebbia, questa dovrebbe essere installata.

Per le modifiche tecniche ed elettroniche eseguite dopo la prima messa in funzione del kit elettrico da parte del costruttore del veicolo, e che portano, per esempio, a un malfunzionamento della presa del rimorchio o della sua periferia, non ci assumiamo alcuna responsabilità!

Il modulo del rimorchio non è idoneo alla diagnosi! Nel caso in cui processi diagnostici o apparecchiature di prova controllate da software dovessero generare dei protocolli d'errore in rapporto diretto o indiretto con l'uso del rimorchio, si deve staccare il modulo del rimorchio dal conduttore per la presa del rimorchio, e avviare nuovamente la diagnosi!

**¡IMPORTANT!**

El montaje del equipo eléctrico deberá llevarse a cabo en un taller especializado o por parte de una persona correspondientemente calificada. Antes de comenzar cualquier trabajo de montaje es imprescindible haberse leído las instrucciones de montaje por completo. ¡Después de haber realizado el montaje del equipo eléctrico deben adjuntarse las instrucciones de montaje a los documentos de servicio del vehículo!

En caso de una utilización inadecuada o de una modificación del equipo eléctrico o de los componentes incluidos respectivamente se extinguirá cualquier derecho de garantía. En caso de conducir sin remolque o sin portacargas deberán sacarse siempre del enchufe los adaptadores que hayan podido ser utilizados. Queda reservado el derecho de modificaciones con respecto a la construcción, el equipamiento, el color y de errores. Todas las informaciones y reproducciones se entienden sin compromiso.

Al tratarse de remolques sin luz antiniebla trasera, esta debería ser reequipada.

¡No asumiremos ninguna clase de garantía por modificaciones técnicas o electrónicas respectivamente que se lleven a cabo después de la primera puesta en funcionamiento del equipo eléctrico por parte del fabricante del vehículo y que puedan provocar por ejemplo un mal funcionamiento del enchufe del remolque o de los correspondientes componentes periféricos!

¡El módulo para el remolque no puede someterse a un diagnóstico! En caso de que los procesos de diagnóstico por parte del fabricante o que los mecanismos de comprobación asistidos por software generen informes de errores que estén directa o indirectamente relacionados con el servicio con remolque, deberá separarse el módulo para el remolque de los cables de conexión para el enchufe del remolque e iniciarse un nuevo proceso de diagnóstico!

**BELANGRIJK!**

De inbouw van deze elektroset moet door een vakwerkplaats of door een overeenkomstig gekwalificeerde persoon gebeuren. Vóór aanvang van alle montagewerkzaamheden absoluut de montagehandleiding volledig doorlezen. Na inbouw van de elektroset dient de montagehandleiding bij de servicedocumenten van het voertuig te worden gelegd!

Bij ondeskundige toepassing of wijziging van de elektroset c.q. van de daarin zittende componenten vervalt elke aanspraak op fabrieksgarantie. Tijdens het rijden zonder aanhanger of ladingdrager moeten evtl. gebruikte adapters altijd uit de stekkerdoos worden verwijderd. Wijzigingen met betrekking tot constructie, uitvoering, kleur alsmede vergissing voorbehouden. Alle opgaven en afbeeldingen niet-bindend.

Bij aanhangers zonder mistachterlicht dient dit achteraf te worden gemonteerd.

Wij verlenen generlei fabrieksgarantie voor technische c.q. elektronische wijzigingen die na de eerste inbedrijfstelling van de elektroset door de voertuigfabrikant worden uitgevoerd en bijvoorbeeld leiden tot foutieve functies van de stekkerdoos van de aanhanger of diens periferie!

De aanhangermodule kan niet worden gediagnosticeerd! Mochten diagnoseprocessen van de kant van de fabrikant c.q. op software steunende testmechanismen foutprotocollen genereren die direct of indirect in verband staan met het gebruik van de aanhanger, dan dient de aanhangermodule te worden losgekoppeld van de kabelset voor de aanhangerstekkerdoos en dient het diagnoseproces nogmaals te worden gestart!

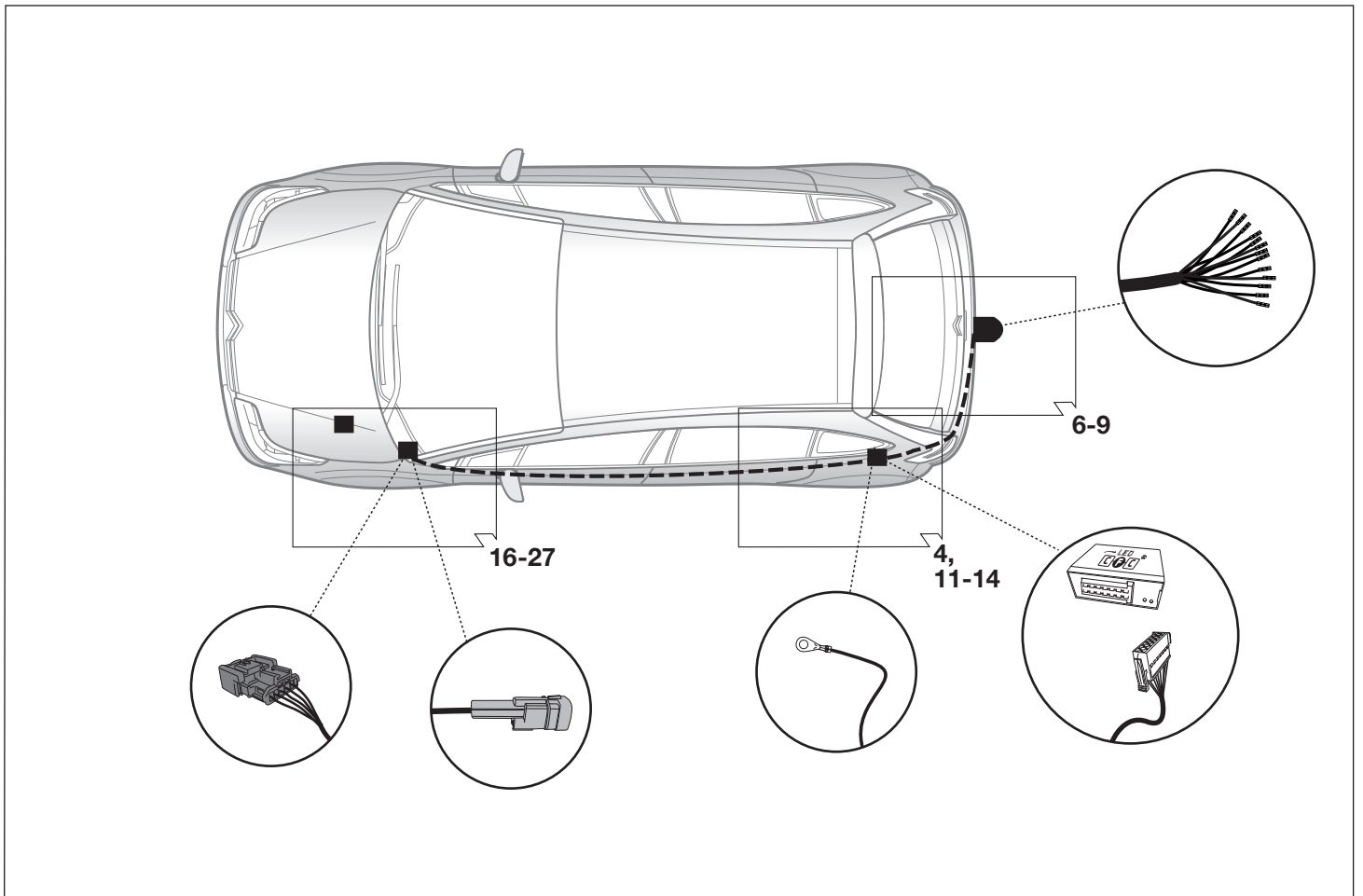
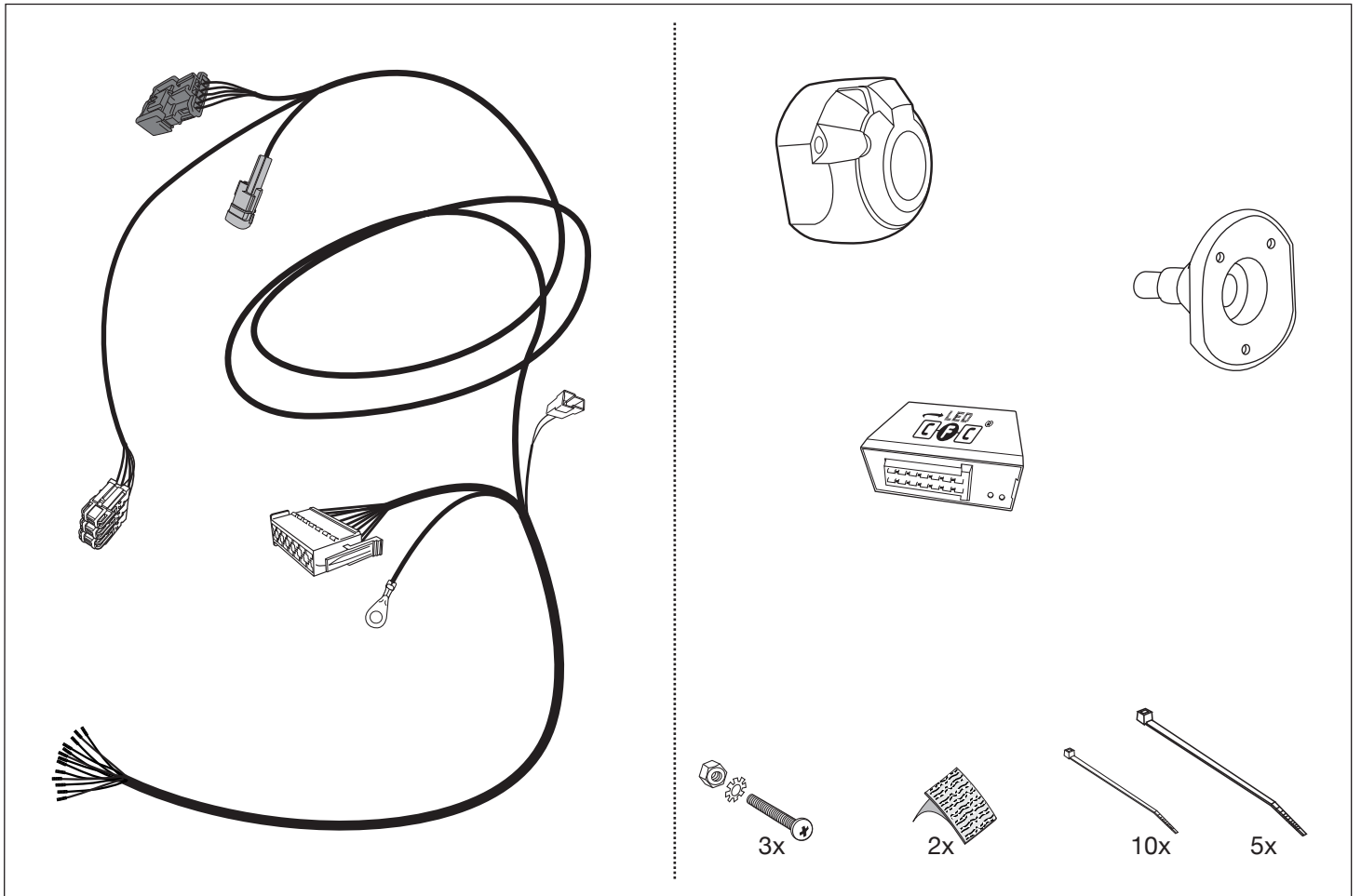

# Werkzeuge - Tools - Outils - Utensile - Herramientas - Werktuigen

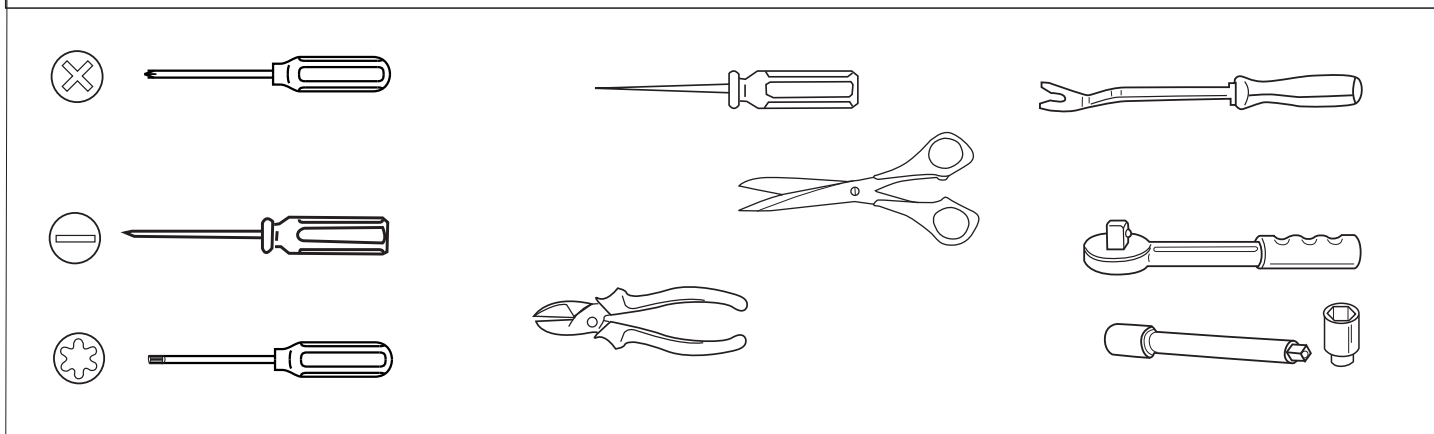

<b>ACHTUNG!</b>	<b>ATTENTION!</b>	<b>ATTENTION!</b>	<b>ATTENZIONE!</b>	<b>¡ATENCIÓN!</b>	<b>ATTENTIE!</b>	
<b>(D)</b>	<b>(GB)</b>	<b>(F)</b>	<b>(I)</b>	<b>(E)</b>	<b>(NL)</b>	
Die Kühlerleistung des Fahrzeuges muß bei Nachrüstung einer Anhängerkupplung möglicherweise erhöht werden! Bitte unbedingt Herstellerangaben beachten!!	The vehicle's cooling capacity may have to be increased when retrofitting a trailer coupling! You must observe the manufacturer's instructions!!	Il peut s'avérer nécessaire d'augmenter la puissance du radiateur du véhicule lorsque celui est équipé ultérieurement d'un attelage remorque! Respecter impérativement les instructions du constructeur!!	La capacità di raffreddamento del veicolo, quando si applica un gancio di traino, si deve possibilmente aumentare! Si prega di osservare tassativamente le indicazioni del produttore!!	¡Es posible que haya que aumentar la capacidad del radiador en caso de reequipar un acoplamiento de remolque! ¡Rogamos tener en cuenta las instrucciones de fabricante sin falta!	Het koelvermogen van het voertuig moet mogelijk worden verhoogd als achteraf een aanhangerkoppeling wordt aangebracht! Absoluut de fabrieksopgaven in acht nemen a.u.b.!!	

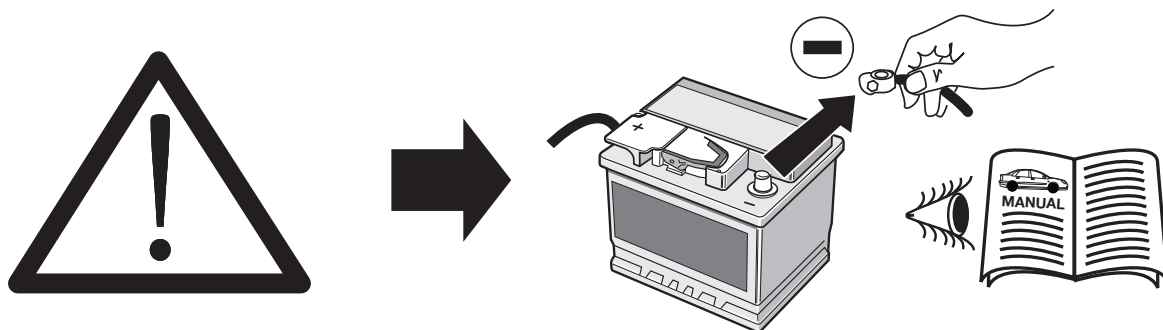

<b>ACHTUNG!</b>	<b>ATTENTION!</b>	<b>ATTENTION!</b>	<b>ATTENZIONE!</b>	<b>¡ATENCIÓN!</b>	<b>ATTENTIE!</b>
<b>(D)</b>	<b>(GB)</b>	<b>(F)</b>	<b>(I)</b>	<b>(E)</b>	<b>(NL)</b>
Um Störungen und Schäden am Bordnetz zu vermeiden, <b>muss</b> die Massepolklemme unbedingt <b>vor Beginn aller Arbeiten</b> von der Fahrzeugbatterie getrennt werden!  Insbesondere bei Arbeiten und Anschlüssen am CAN-Datenbus kann bei nicht abgeklemmter Batterie sowohl das Anhängermodule als auch das <b>fahrzeugseitige</b> Bordnetzsteuergerät beschädigt werden!  Bitte Herstellervorschriften beim Ab- und Anklemmen der Fahrzeugbatterie beachten!	In order to avoid mal-functions and damage to the vehicle's electrical system the earth terminal <b>must</b> be disconnected from the vehicle's battery <b>before starting work!</b>  Both the trailer module and the vehicle's control unit for the electrical system can be damaged during work on the CAN data bus connections if the battery is not disconnected!  Please pay attention to the manufacturer's instructions when disconnecting and reconnecting the vehicle's battery!	Afin d'éviter tout dysfonctionnement ou endommagement du circuit de bord, il est <b>indispensable</b> de débrancher la pince de masse de la batterie du véhicule <b>avant le début de toute opération!</b>  En particulier s'il s'agit de travaux et de branchements effectués sur le bus de données CAN, si la batterie n'est pas débranchée, le module remorque aussi bien que le dispositif de commande de circuit de bord du véhicule risquent d'être endommagés!  Veuillez respecter les directives du fabricant lors du branchement et du débranchement de la batterie du véhicule!	Per evitare disturbi e danni alla rete di distribuzione elettrica, l'espansione polare a massa <b>deve</b> essere assolutamente scollegata dalla batteria del veicolo <b>prima dell'inizio dei lavori!</b>  In particolare durante i lavori e gli allacciamenti al bus di dati CAN, se la batteria non è scollegata si possono danneggiare sia la centralina rimorchio, sia la centralina della rete di distribuzione elettrica del veicolo!  Attenersi alle indicazioni del costruttore per scollegare e ricollegare la batteria del veicolo!	¡Para evitar fallos y defectos en el sistema eléctrico de a bordo <b>es imprescindible</b> separar al terminal de puesta a tierra de la batería del vehículo <b>antes de reali-zar cualquier trabajo!</b>  ¡Particularmente al realizar trabajos y conexiones al bus de datos CAN puede estropearse tanto el módulo para remolques como el regulador del sistema eléctrico de a bordo del vehículo si no se ha desconectado la batería!  ¡Rogamos observar las instrucciones del fabricante al conectar y desconectar la batería del vehículo!	Om storingen en schade aan de elektrische bedrading te vermijden <b>moet</b> de massapoolklem absoluut <b>vóór aanvang van alle werkzaamheden</b> worden losgekoppeld van de voertuigaccu!  Vooral bij werkzaamheden aan aansluitingen op de CAN-databus kan zowel de aanhangermodule als de voertuigzijdige regelenheid voor de elektrische installatie beschadigd worden, als de accu niet ontkoppeld is!  Fabrieksvorschriften bij het vast-en loskoppelen van de voertuigaccu in acht nemen a.u.b.!

**C4 Picasso**

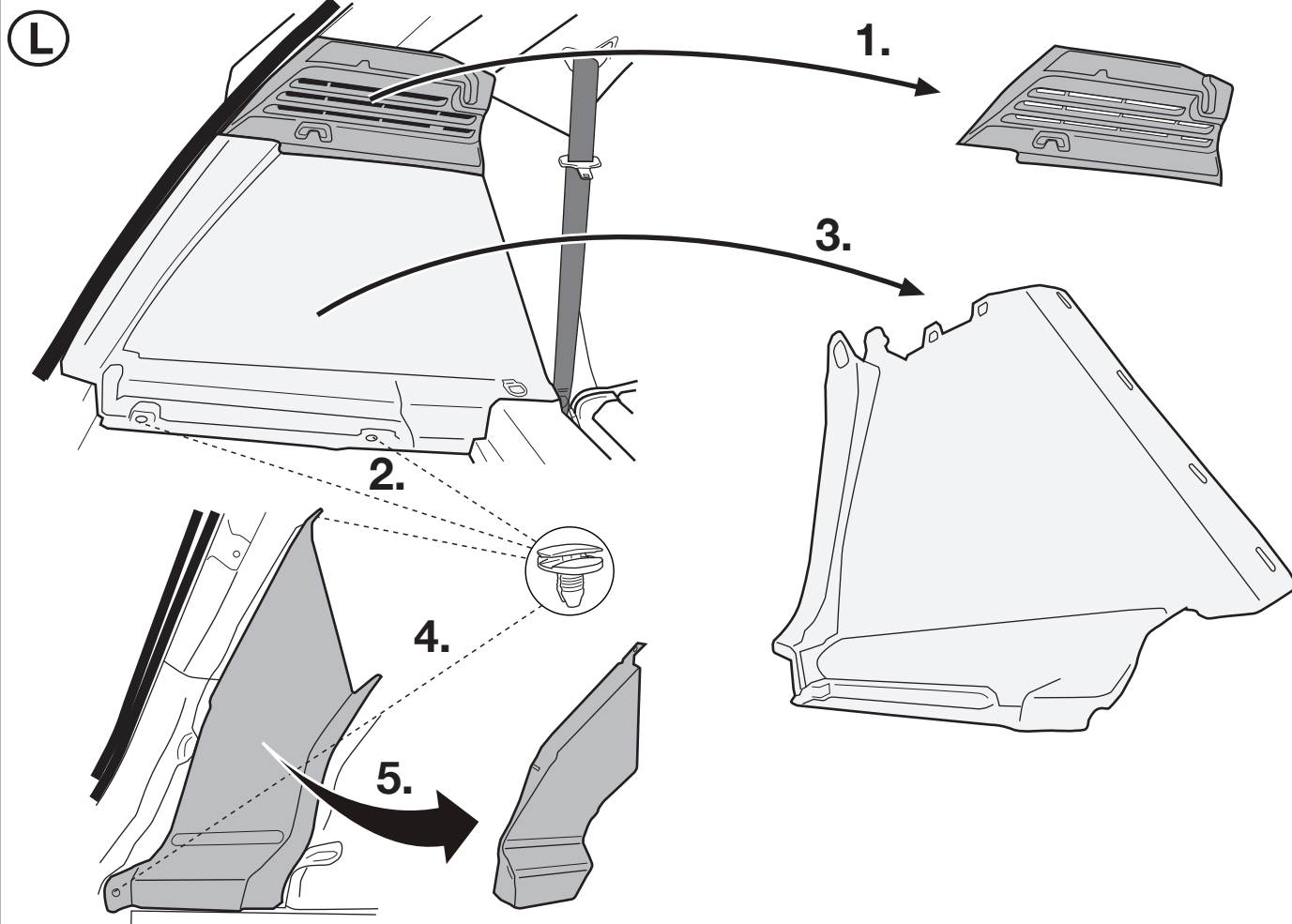
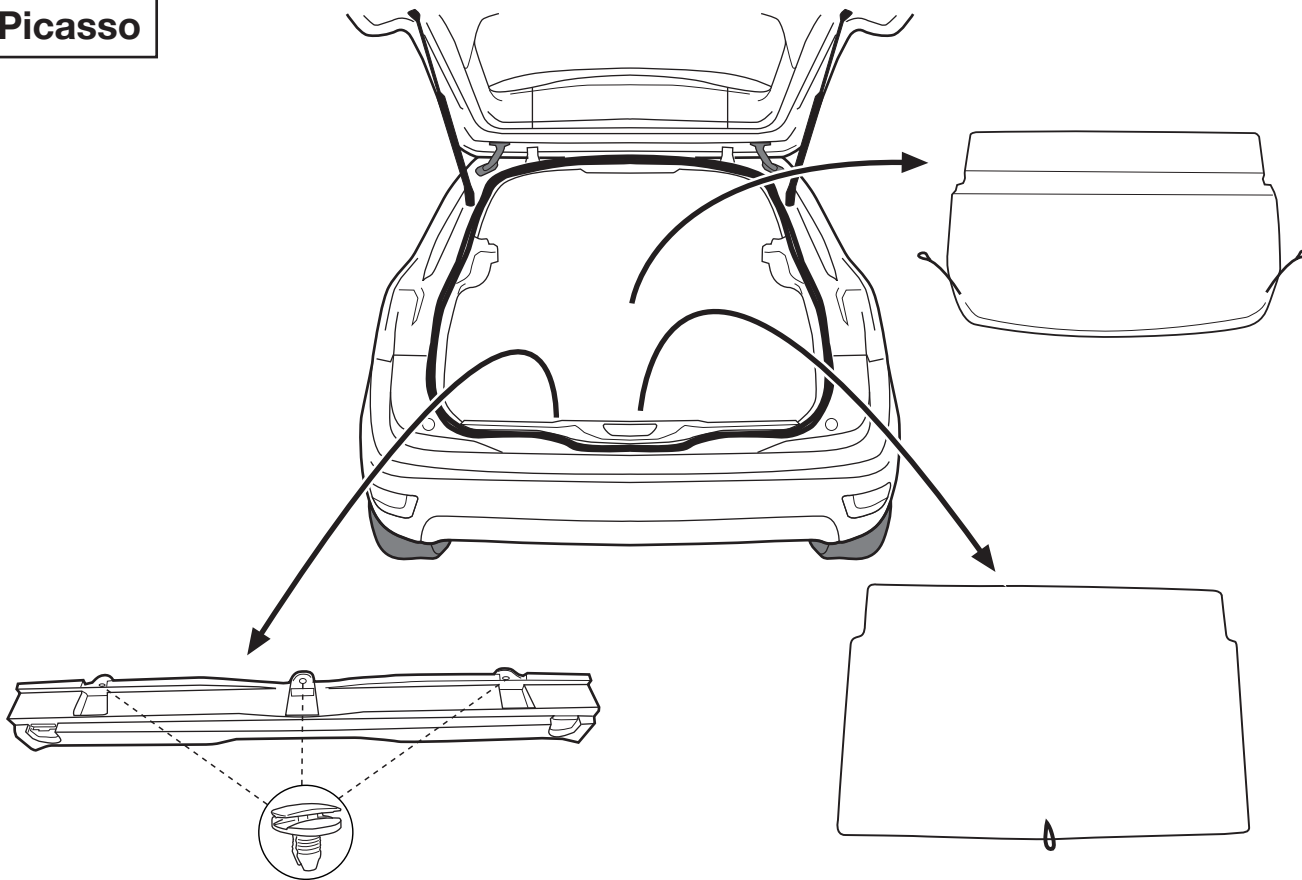



# Grand C4 Picasso

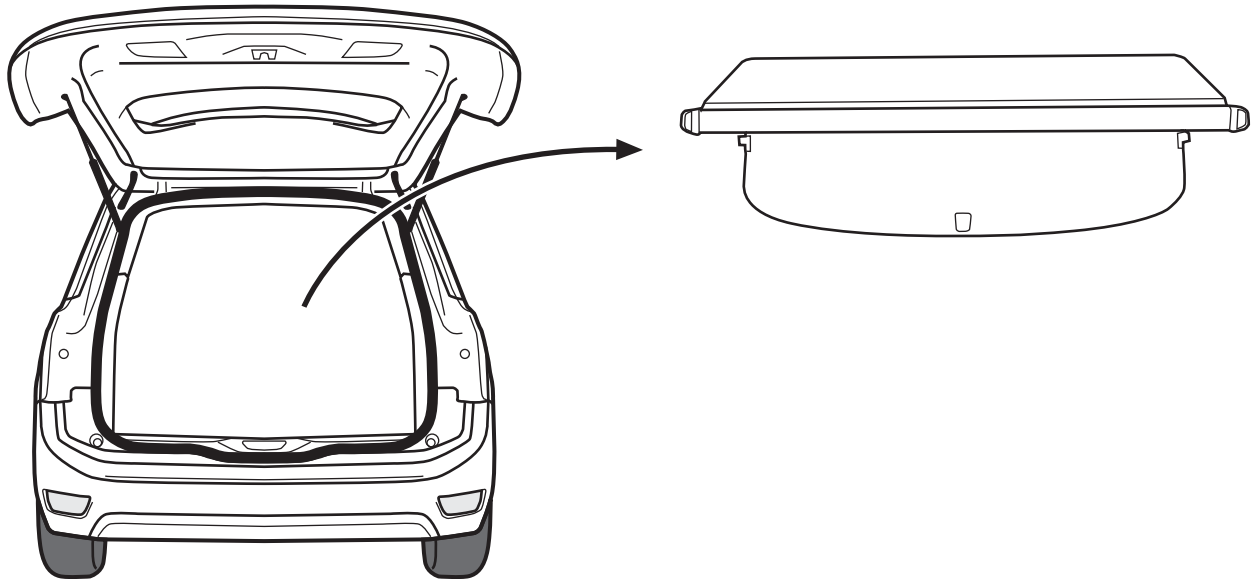

**L**

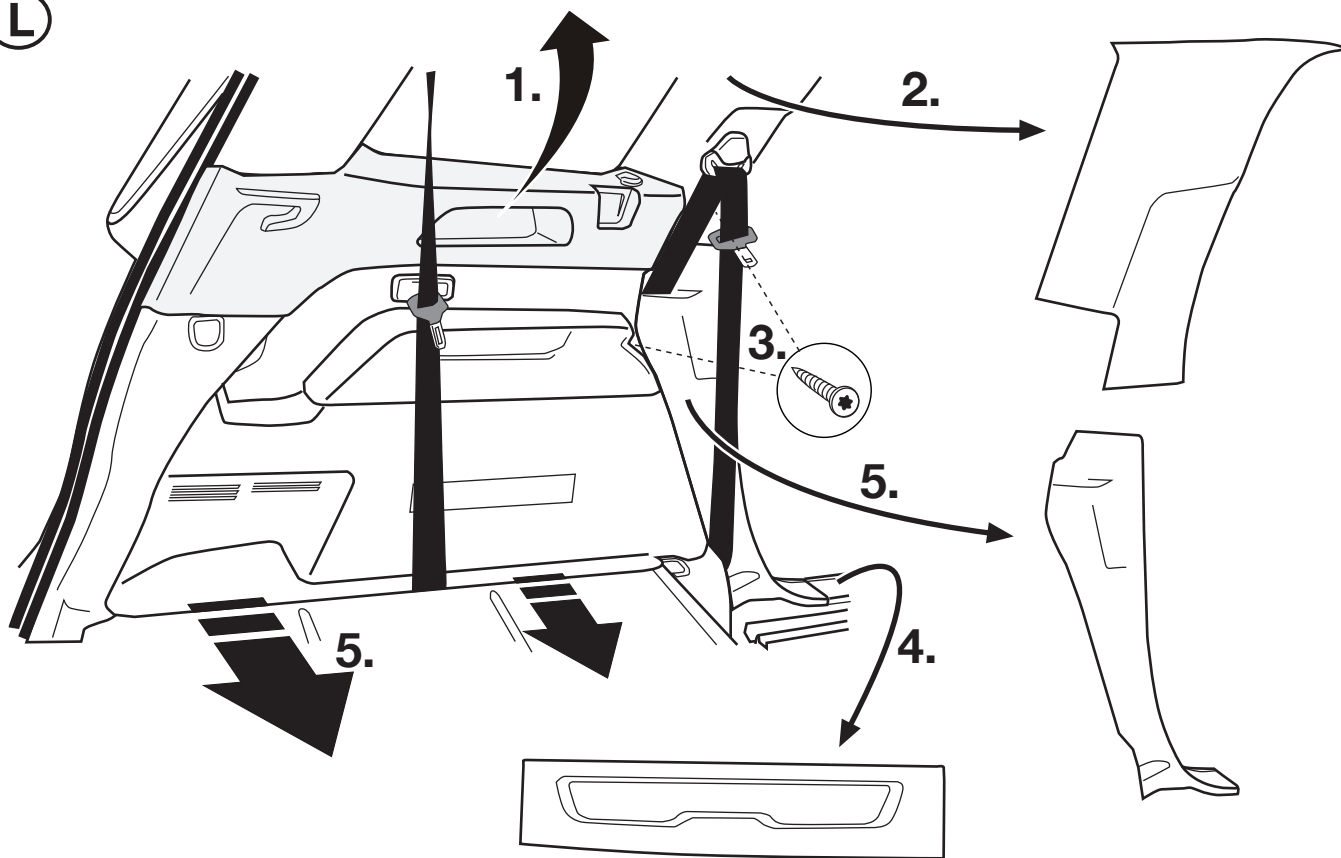

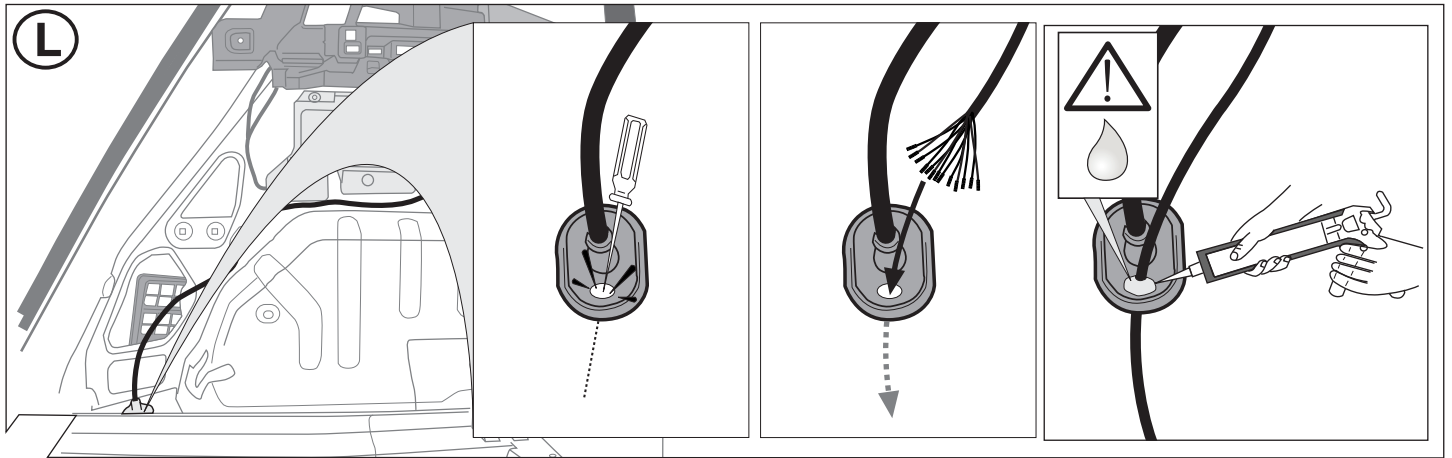

4

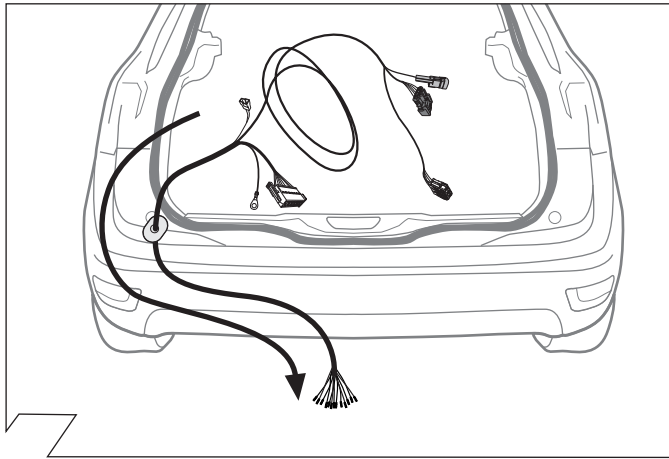

5

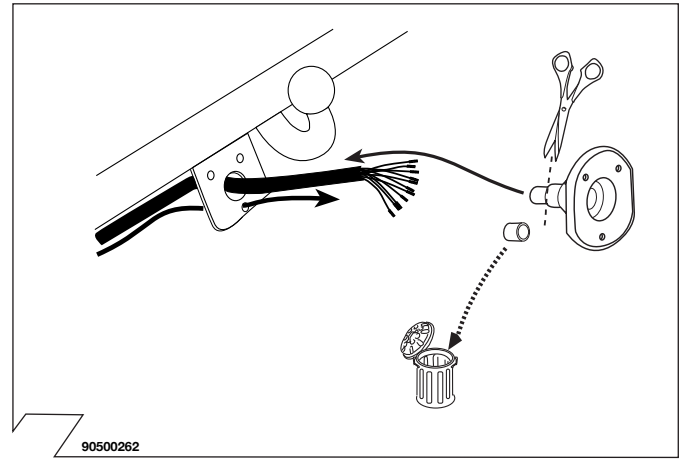

6

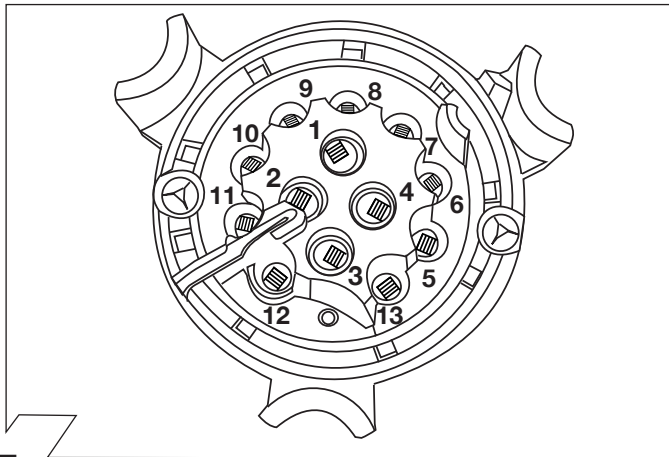

7

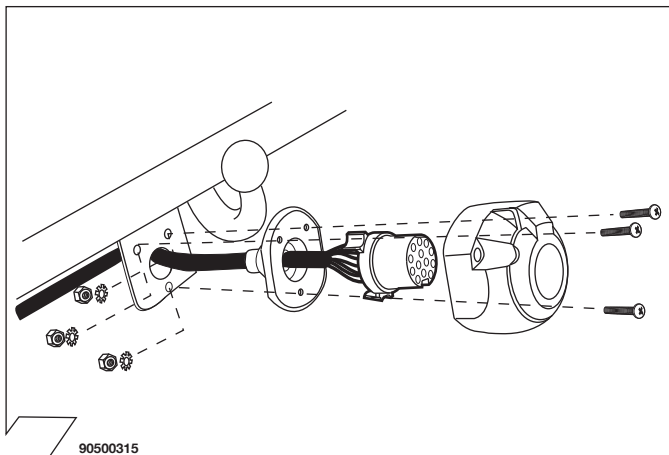

8

ISO 11446	Belegung der Steckdose / Maximale Ausgangsleistung Socket configuration / Maximum power output Correspondance des contacts de la prise / Puissance de sortie maximale Abbinamento della presa / Uscita di alimentazione massima Indeling van de stekkerdoos / maximaal uitgangsvermogen		
	1/L	BK/WT	21W
	2	WT	42W
	3/31	BR	
	4/R	BK/GN	21W
	5/58-R	GY/RD	52W
	6/54	BK/RD	63W
	7/58-L	GY/BK	52W
	8	BL/RD	42W
	9	RD	240W
	10	YL	180W
	11	YL/BR	
	12		
	13	RD/BR	

9

	GB	D	E	F	I	P	NL	DK	N	S	FIN	CZ	H	PL
BK	Black	Schwarz	Negro	Noir	Nero	Preto	Zwart	Sort	Svart	Svart	Musta	Černá	Fekete	Czarny
RD	Red	Rot	Rojo	Rouge	Rosso	Vermelho	Rood	Rød	Red	Röd	Punainen	Červená	Piros	Czerwony
GN	Green	Grün	Verde	Vert	Verde	Verde	Groen	Grøn	Grønt	Grøn	Vihreä	Zelená	Zöld	Zielony
OR	Orange	Orange	Naranja	Orange	Arancione	Laranja	Oranje	Orange	Orange	Orange	Oranssi	Oranzová	Narancs	Pomarańczowy
VT	Violet	Violett	Violeta	Violet	Viola	Violeta	Violet	Violet	Fiolett	Violett	Violetti	Fialová	Ibolya	Fioletowy
PK	Pink	Pink	Pink	Rose	Rosa	Cor-de-Rosa	Paars	Pink	Pink	Rosa	Pinkki	Růžová	Rózsaszín	Różowy
BL	Blue	Blau	Azul	Bleu	Blu	Azul	Blauw	Blå	Blått	Blå	Sininen	Modrá	Kék	Niebieski
YL	Yellow	Gelb	Amarillo	Jaune	Giallo	Amarelo	Geel	Gul	Gult	Gul	Keltainen	Zlutá	Sárga	Żółty
WT	White	Weiss	Blanco	Blanc	Bianco	Branco	Wit	Hvid	Hvitt	Vit	Valkoinen	Bílá	Fehér	Biały
BR	Brown	Braun	Marrón	Brun	Marrone	Marrom	Bruin	Brun	Brunt	Brun	Ruskea	Hnědá	Barna	Brazowy
GY	Grey	Grau	Gris	Gris	Grigio	Cinzeno	Grijs	Grå	Grått	Grå	Harmaa	Sedá	Szürke	Szary

90500580

10

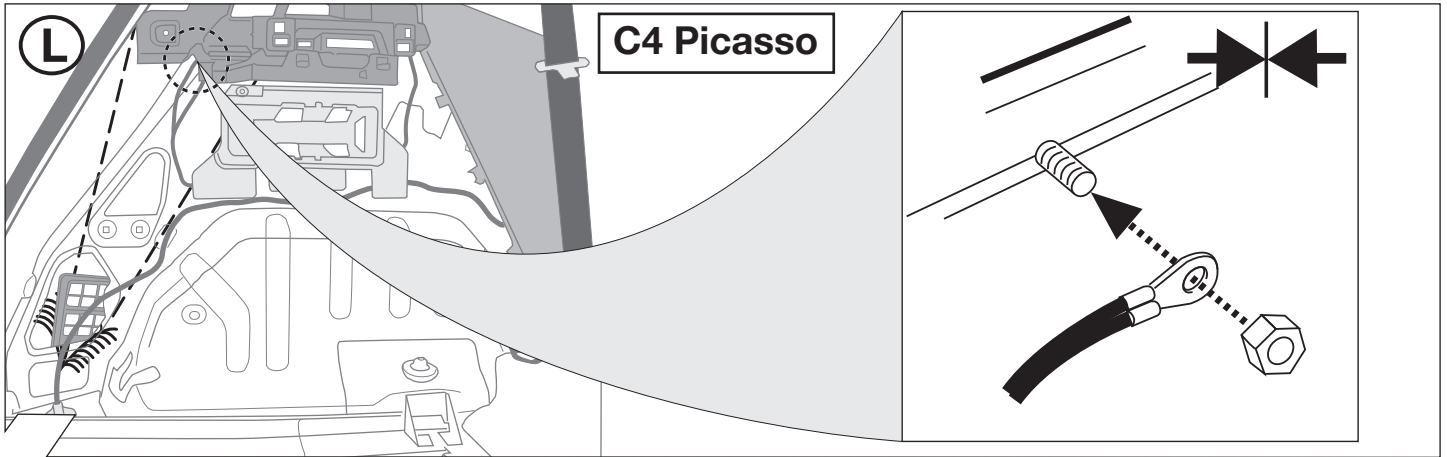

11

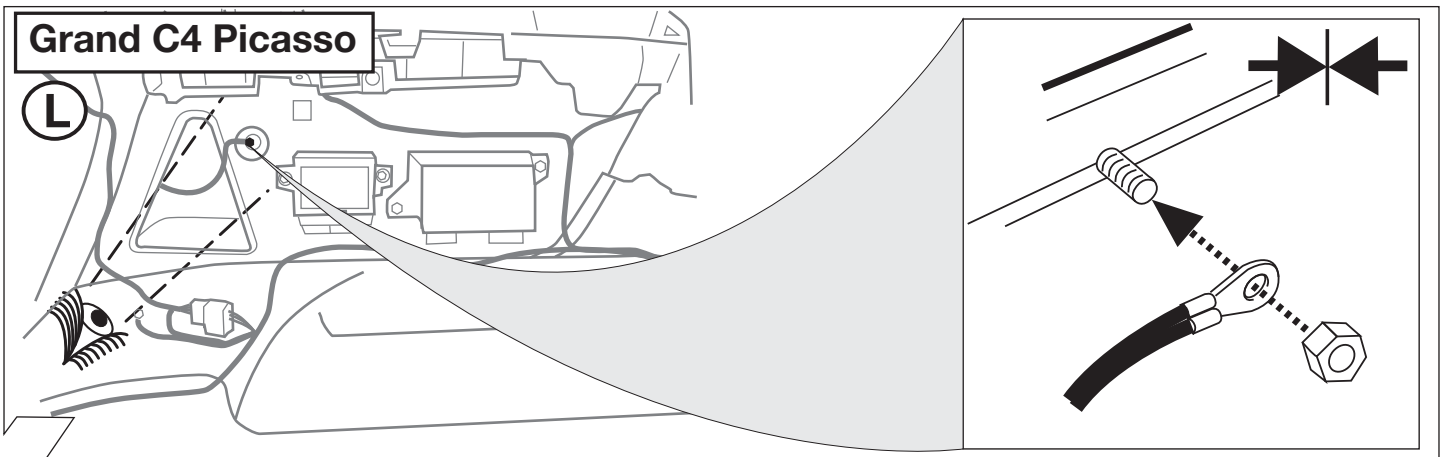

12

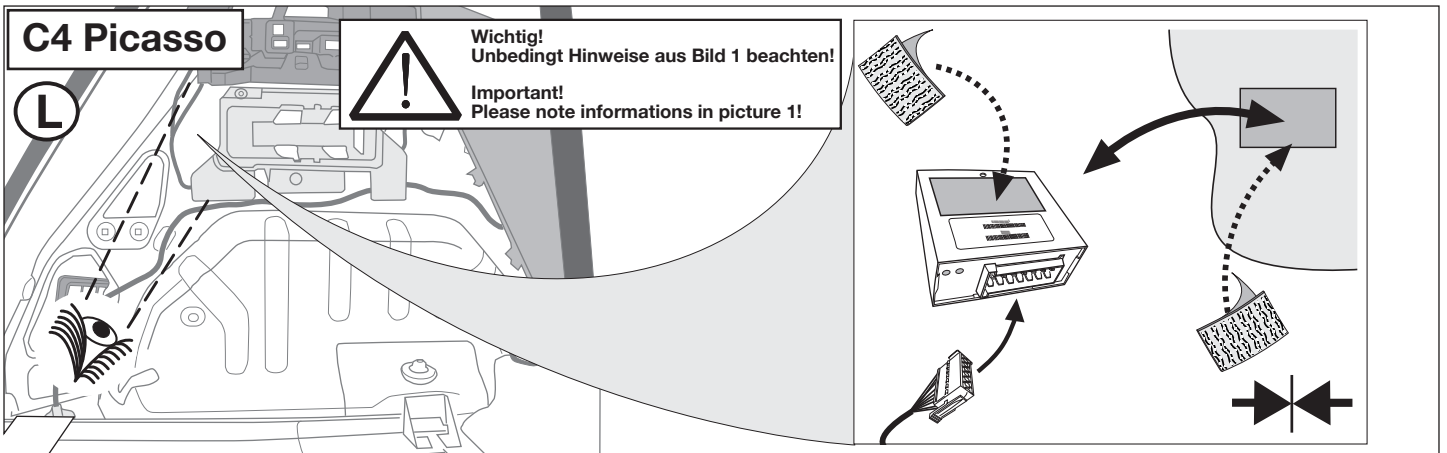

13



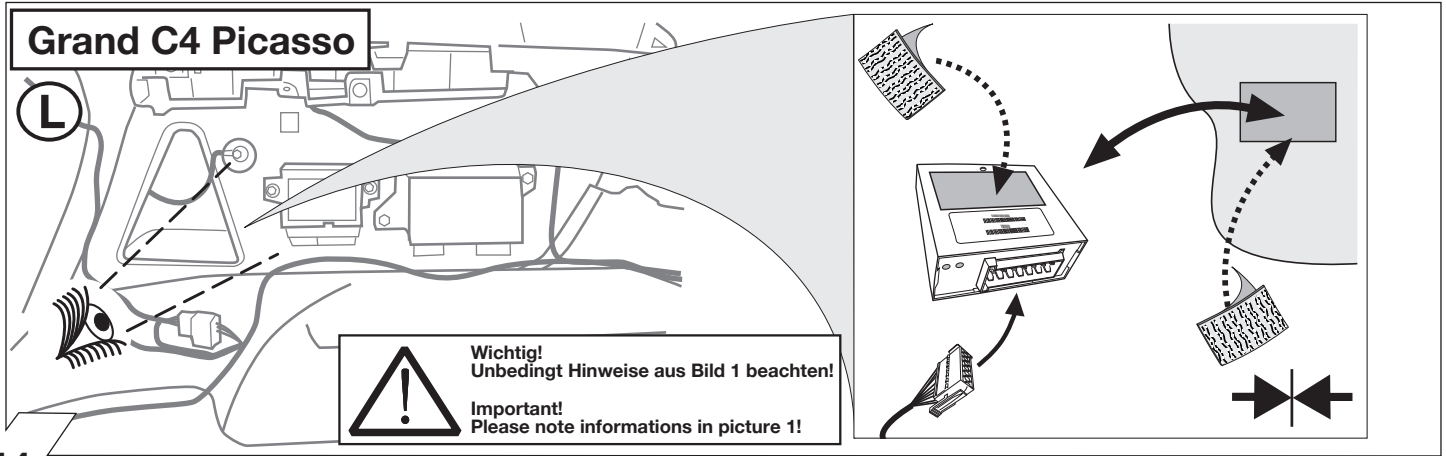

14

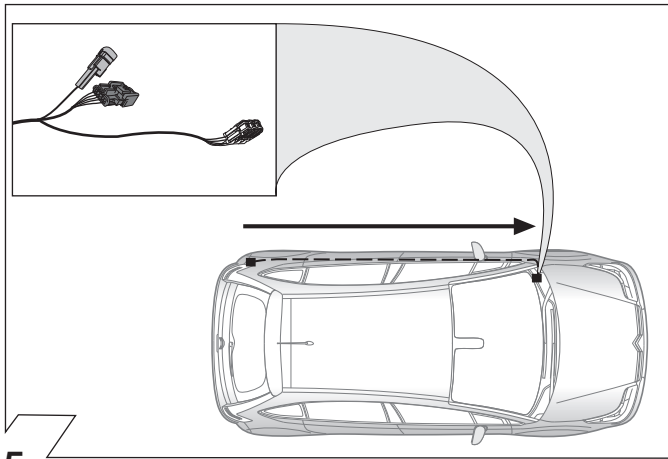

15

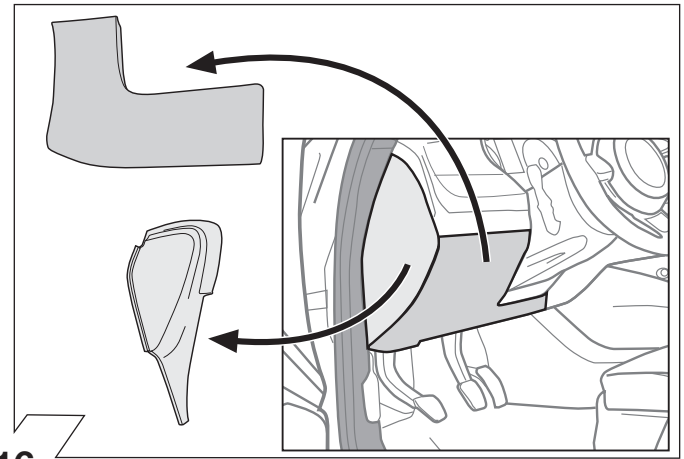

16

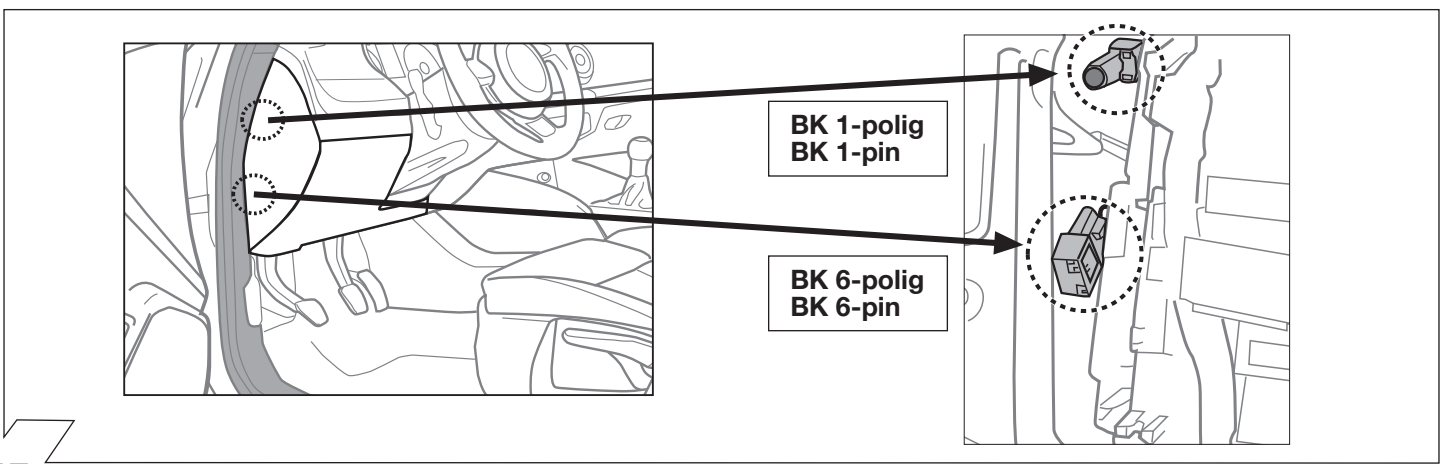

17

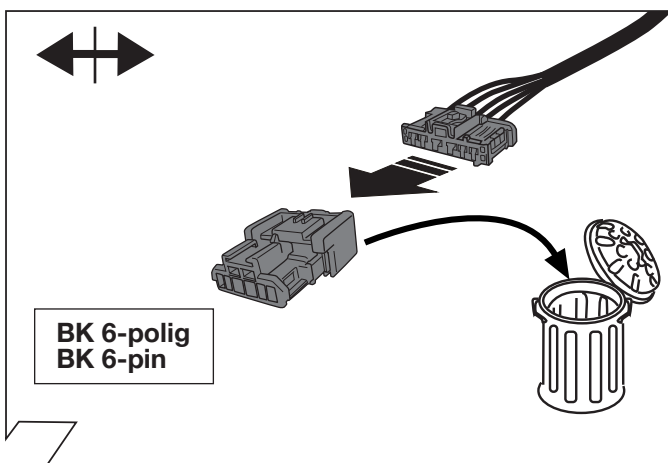

18

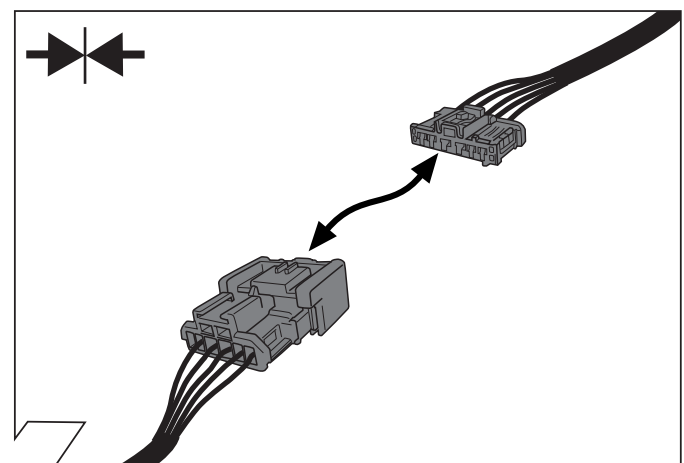

19

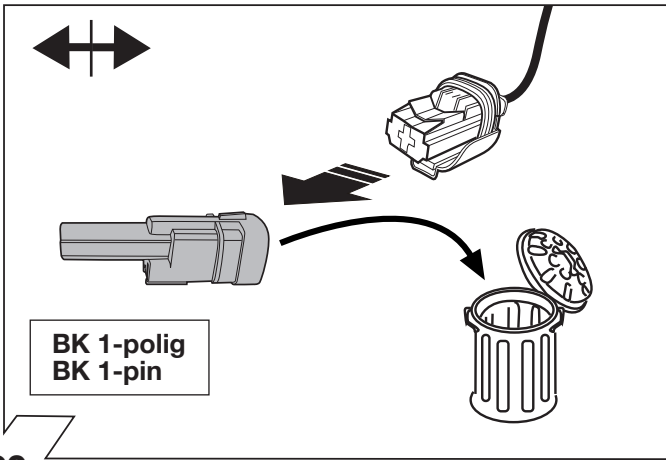

20

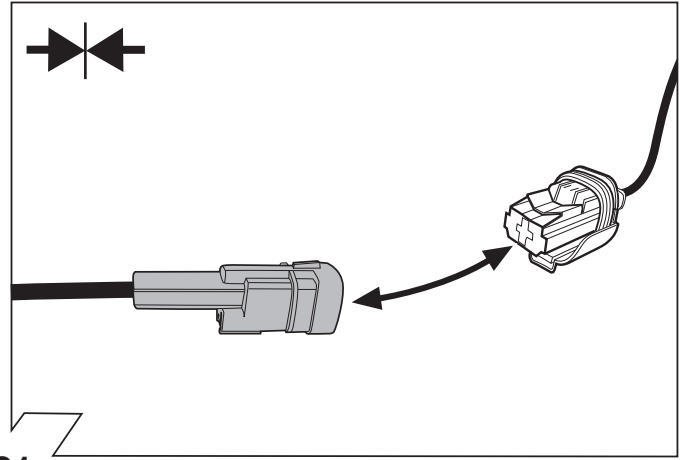

21

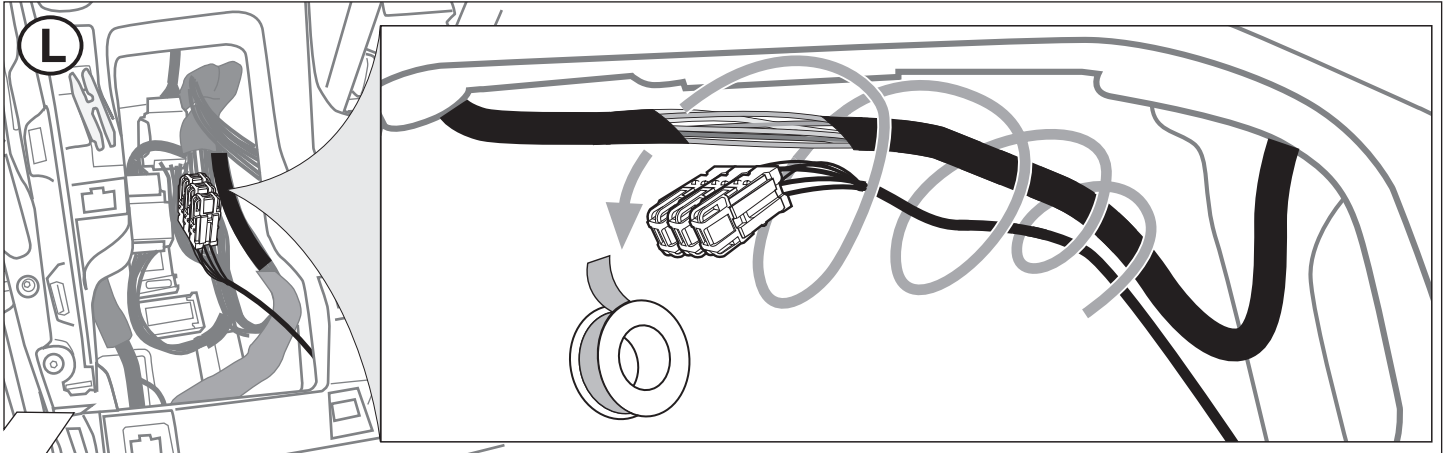

22

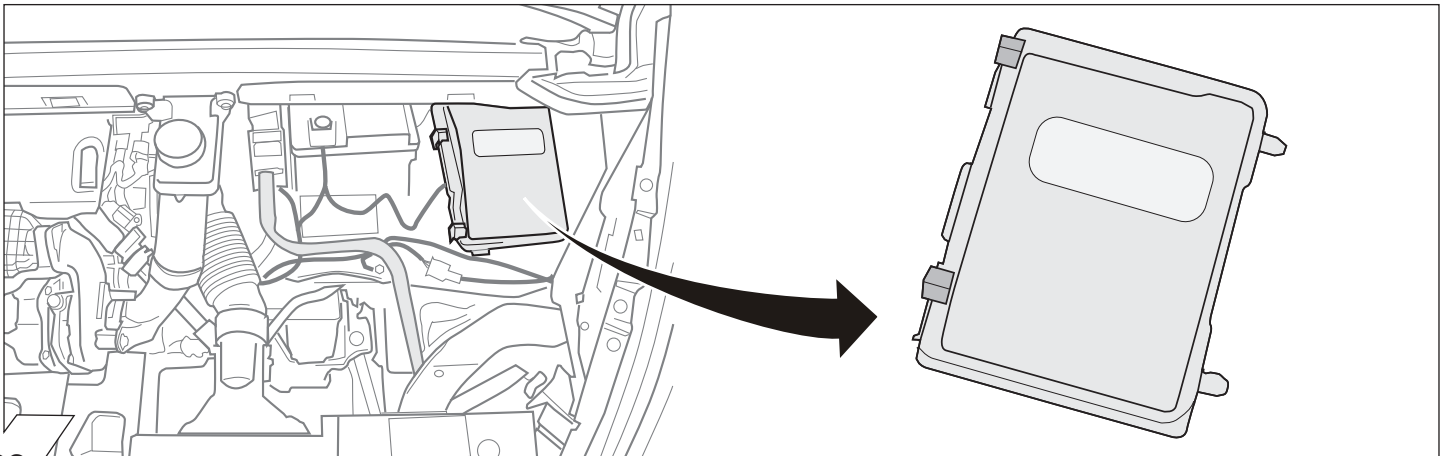

23

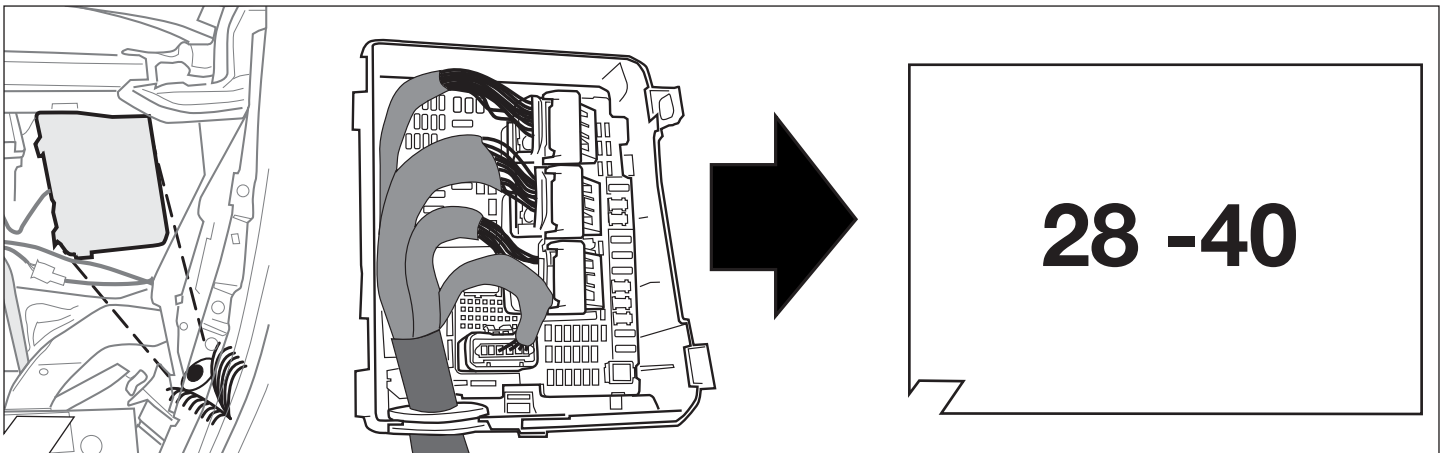

24

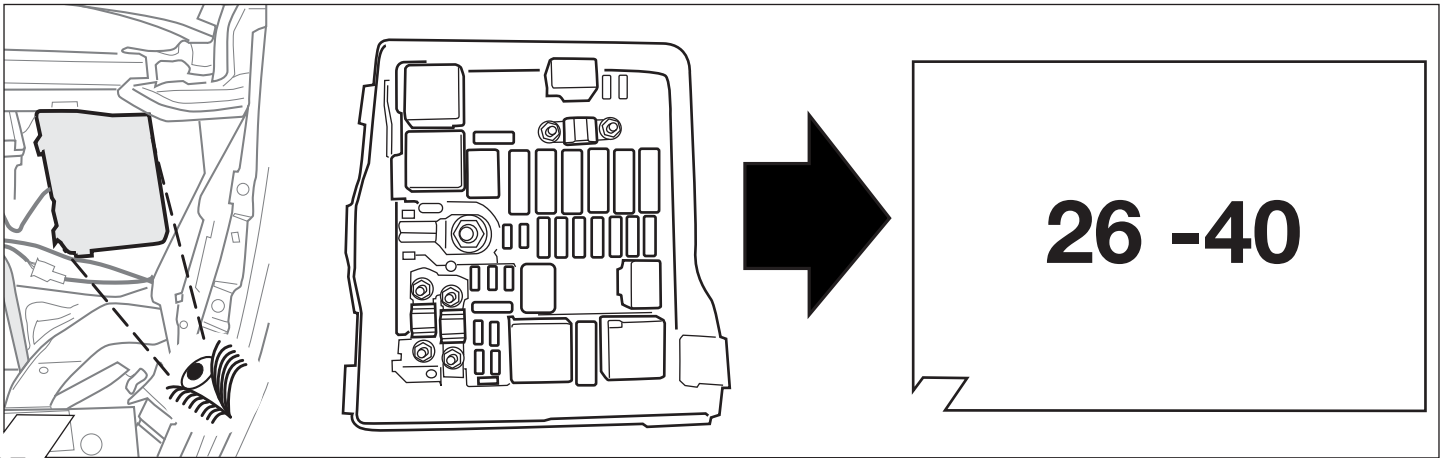

25

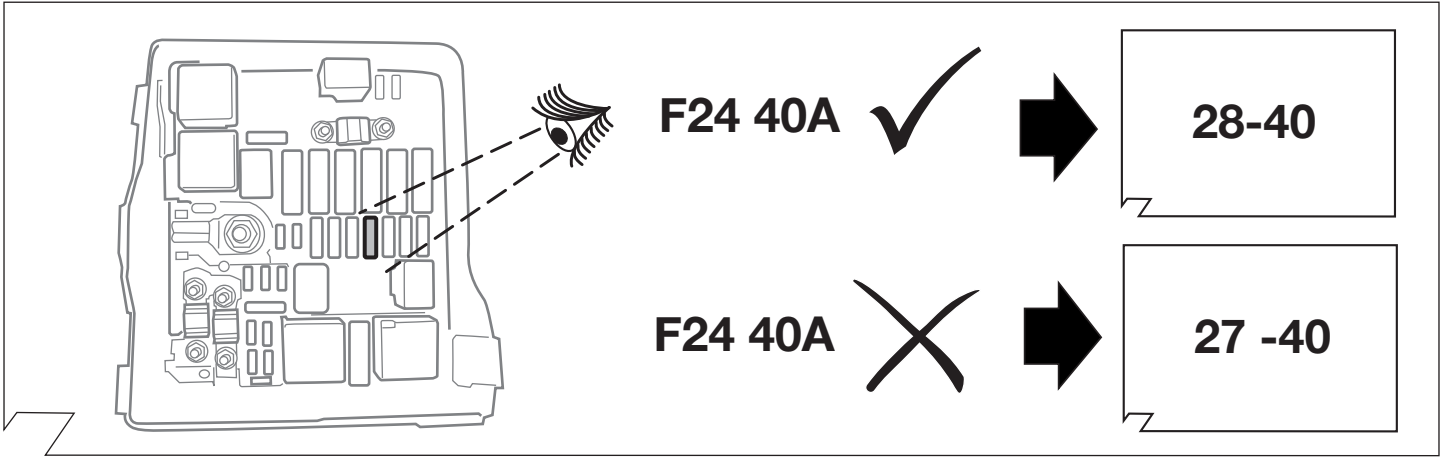

26

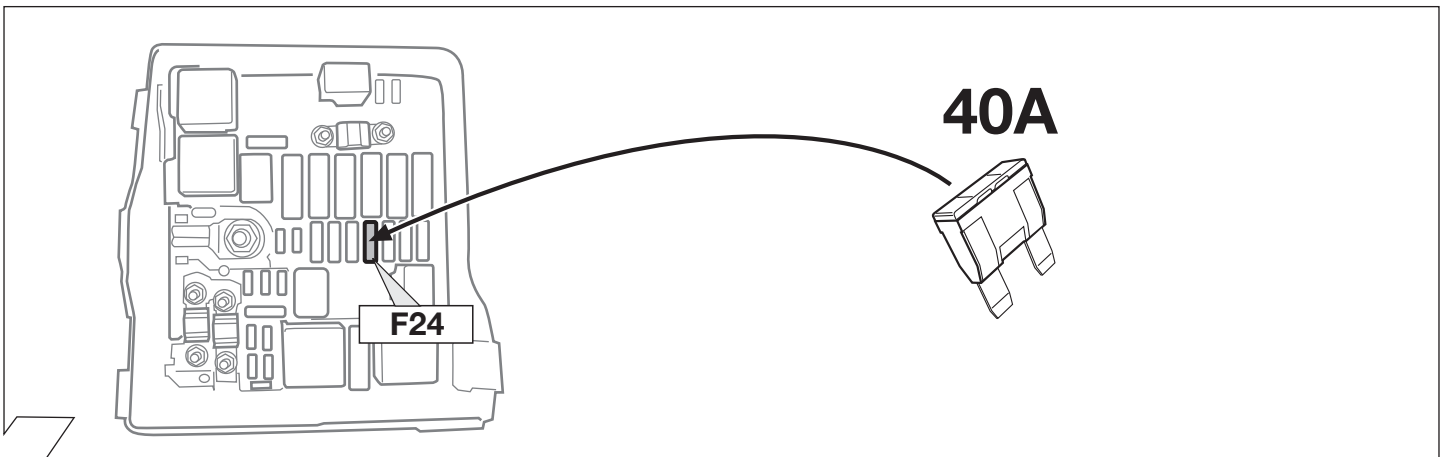



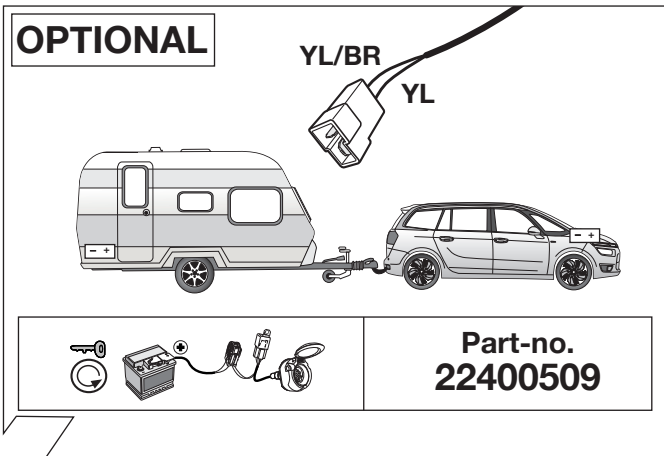

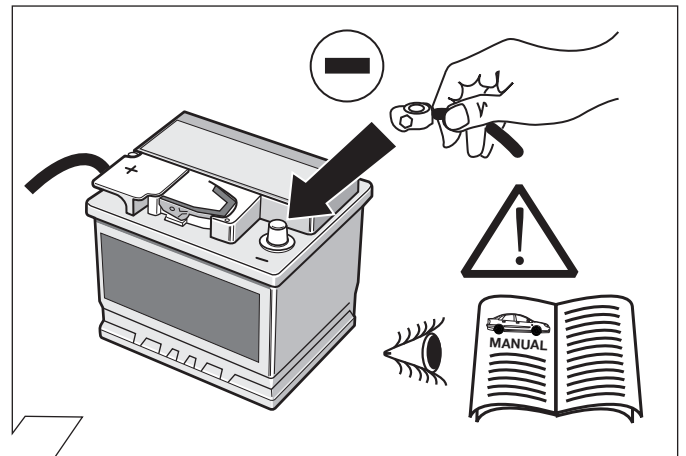

27



28



29

 <p>Folgende Beleuchtungsfunktionen des Anhängers werden nicht bei allen Zugfahrzeugen mit Tagesfahrlichtschaltung unterstützt:</p> <ul style="list-style-type: none"> <li>• Schlussleuchten</li> <li>• Begrenzungsleuchten</li> <li>• Kennzeichenbeleuchtung</li> </ul> <p>Zur Aktivierung dieser Funktionen muss Stand- oder Abblendlicht eingeschaltet werden!</p>	 <p>Le seguenti funzioni per l'illuminazione del rimorchio non sono supportate da tutte le motrici con circuito di luci diurne:</p> <ul style="list-style-type: none"> <li>• luci posteriori</li> <li>• luci d'ingombro</li> <li>• illuminazione targa</li> </ul> <p>Per attivare queste funzioni devono essere accese le luci di posizione o gli anabbaglianti!</p>
 <p>The following lamp functions for the trailer are not supported by all towing vehicles with DRL circuit:</p> <ul style="list-style-type: none"> <li>• Rear lights</li> <li>• Side lights</li> <li>• Numberplate lights</li> </ul> <p>The parking lights or dimmed headlights must be switched on to activate this function!</p>	 <p>De volgende verlichtingsfuncties van de aanhanger worden niet bij alle trekkende voertuigen met daglichtschakeling ondersteund:</p> <ul style="list-style-type: none"> <li>• Achterlichten</li> <li>• Spatbordlampen</li> <li>• Kentekenverlichting</li> </ul> <p>Ter activering van deze functies moet parkeer- of dimlicht worden ingeschakeld!</p>
 <p>Les fonctions d'éclairage suivantes de la remorque ne sont pas activables sur tous les véhicules de traction équipés de feux de circulation de jour:</p> <ul style="list-style-type: none"> <li>• Feux arrières</li> <li>• Feux d'encombrement</li> <li>• Éclairage de la plaque minéralogique</li> </ul> <p>Pour activer ces fonctions, les feux de position ou de croisement doivent être allumés!</p>	 <p>No todos los vehículos tractores con conmutación de luz de marcha diurna ofrecen un soporte para las siguientes funciones de iluminación del remolque:</p> <ul style="list-style-type: none"> <li>• Luces traseras</li> <li>• Luces de gálibo</li> <li>• Iluminación de la matrícula</li> </ul> <p>¡Para activar estas funciones deberán encenderse las luces de posición o las luces de cruce!</p>



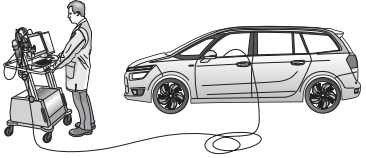

30



**Codierung Steuergerät**  
Code Control unit  
Codage dispositif de commande  
Codifica dispositivo di controllo  
Bedieningsapparaat coderen  
Contralor de codificacion

Seite 14  
page 14  
pagina 14  
pagina 14

31

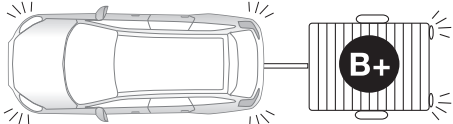
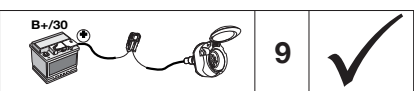







32

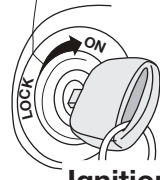



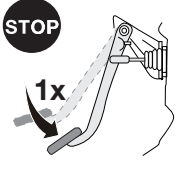

**SETUP**

1. 

2.  Ignition ON

3.  STOP 1x

4.   

33

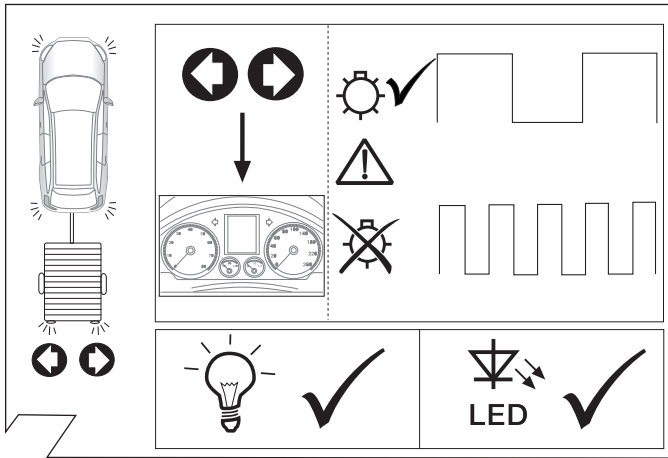

34

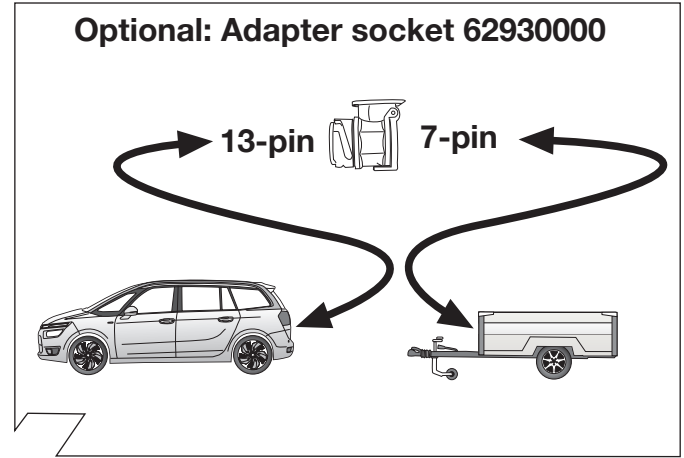

35

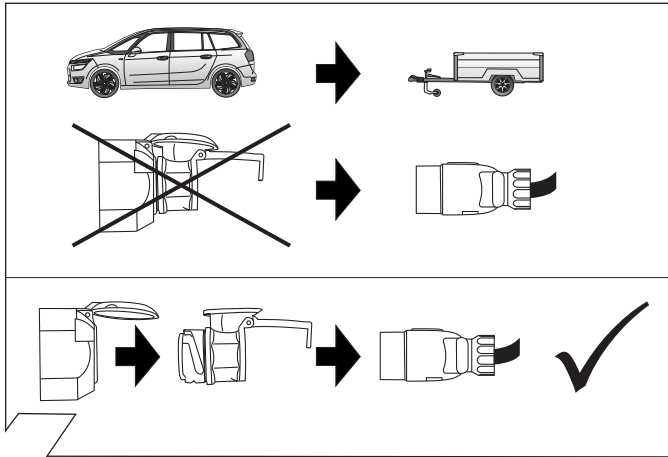

36

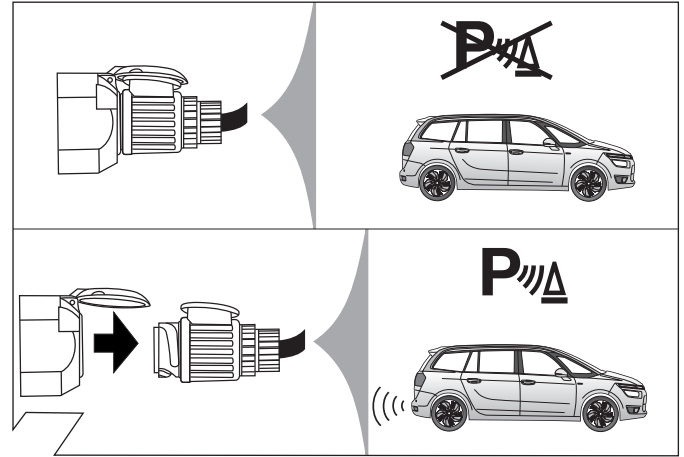

37

**OPTIONAL**

**Trailer Simulator for 7- and 13-pin Sockets**

Part-no. 50400107J

38

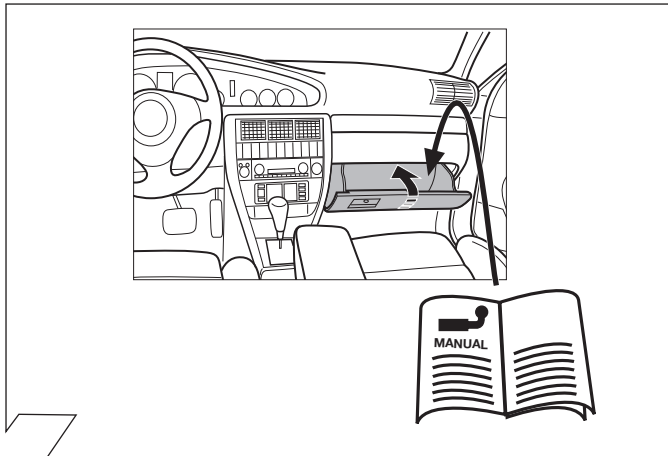
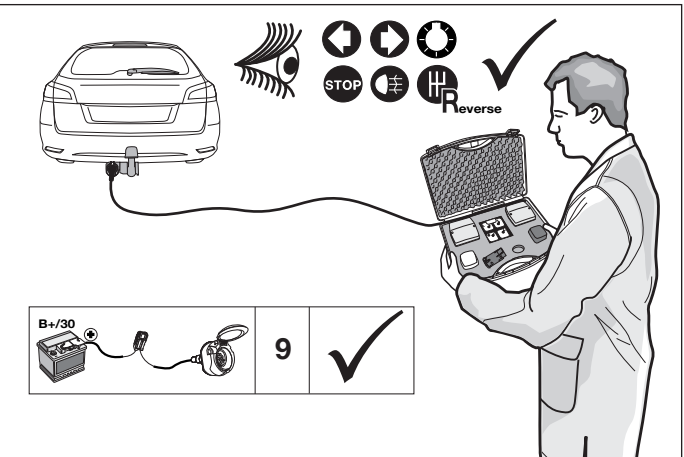

39



## Anhängerbetrieb konfigurieren / Set up trailer operation

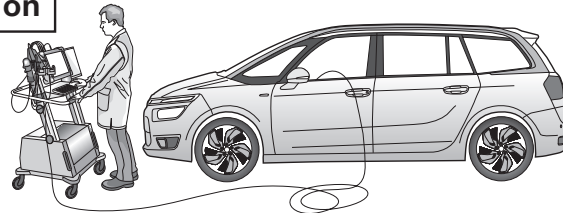

Die Aktivierung der Anhängerfunktionen

muss mit Hilfe des CITROËN Lexia-Testers wie folgt durchgeführt werden:

- Fahrzeug auswählen
- Auslieferung
- Ausstattungen
- Schalteinheit Anhänger (BSR)
- Installation einer Ausstattung



The activation of the trailer functions

has to be carried out using the CITROËN Lexia tester as follows:

- choose vehicle
- delivery
- equipment
- trailer control unit (BSR)
- installation of equipment



L'activation des fonctions de la remorque

doit être effectuée comme suit à l'aide du testeur Lexia CITROËN:

- choisir des véhicules
- livraison
- équipements
- partie commutation - remorque (BSR)
- installation d'un équipement



L'attivazione di rimorchio funzioni

si deve eseguire con l'aiuto del tester CITROËN Lexia come segue:

- Scegliere veicolo
- I tempi di consegna
- Attrezzature
- Centralina rimorchio (BSR)
- L'installazione di apparecchiature



La activación del funciones de remolque

deberá llevarse a cabo con ayuda del comprobador Lexia de CITROËN de la siguiente manera:









- elegir vehículo
- entrega
- equipo
- unidad de conmutación - remolque (BSR)
- instalación de equipos i

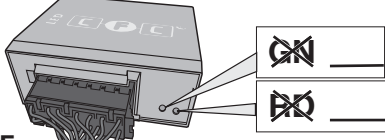

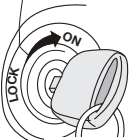
De activering van de trailer-functies

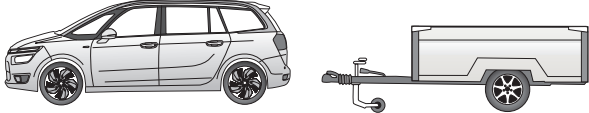
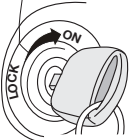
moet met behulp van de CITROËN Lexia-tester als volgt worden uitgevoerd:

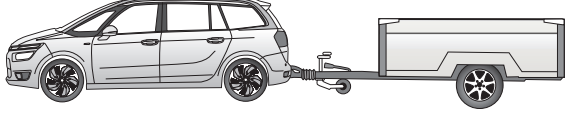
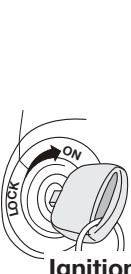
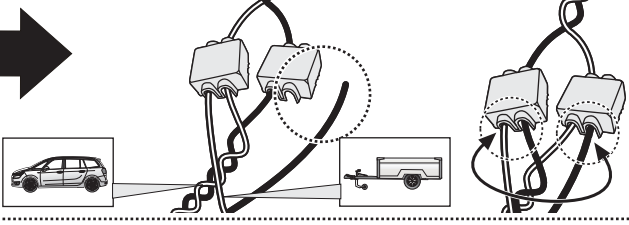
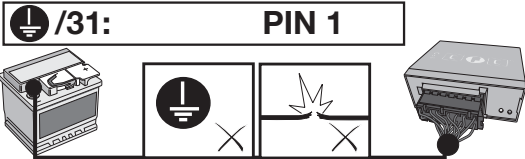
- Kies het voertuig
- Levering
- Apparatuur
- Schakelunit aanhanger (BSR)
- Installatie van apparatuur

D Diagnosefunktion der Kontroll-LED's	GB Diagnosis function of control LEDs	F Fonction diagnostic des LED de contrôle
I Funzione di diagnostica dei LED di controllo	E Función de diagnóstico de los LEDs de control	NL Diagnosefunctie van de controle-LED's
 <p>Ignition OFF</p>	 <p>No CAN-Data =</p>	 <p>Standby / Sleepmode ✓</p>
 <p>Ignition ON</p>	 <p>GN</p>	 <p>✓</p>
 <p>Ignition ON</p>	 <p>GN</p>	 <p>✓</p>
 <p>Ignition ON</p>	<p>RD</p> <p>oder or</p> <p>RD</p>	<p><b>CAN-Data Wire PIN 13+14</b></p>  <p>✗</p> <p><b>↓/31: PIN 1</b></p>  <p>✗</p>
 <p>Ignition ON</p>	<p>RD</p>	<p><b>B+/30: PIN 2 oder/or 4</b></p>  <p>✗</p>
<p><b>D Leuchtensubstitution bei Ausfall der Anhänger-Blinkleuchten</b></p> <p>Der Ausfall einer Anhänger-Blinkleuchte (rechts, links oder beidseitig) wird dem Fahrer im Kombi-Instrument des Zugfahrzeugs über eine Textmeldung im Display, eine Blinkfrequenzerhöhung und/oder durch das Aufleuchten einer Kontrollleuchte für Lampenausfall angezeigt.</p> <p><b>Bei aktiviertem Fahrtrichtungsanzeiger wird außerdem die entsprechende Rückleuchte des Anhängers zur Blinkleuchte (► Leuchtensubstitution):</b></p> <p>Bei Blinkleuchtausfall ersetzt die linke bzw. rechte Rückleuchte durch Aufleuchten in der Blinkfrequenz die defekte Blinkleuchte!</p> <p><b>Die Leuchtensubstitution funktioniert nicht bei aktiviertem Warnblinker.</b></p>	<p><b>GB Lamp substitution if the trailer indicators fail</b></p> <p>The failure of a trailer indicator (right left or both sides) is reported to the driver in the towing vehicle's combi-instrument via a text message in the display, an increase in the flashing frequency and/or a control lamp for light failure coming on.</p> <p><b>If the indicator is activated, the corresponding rear lamp on the trailer becomes the indicator (► lamp substitution):</b></p> <p>If an indicator fails the left or right rear light compensates the faulty indicator by flashing at the correct frequency!</p> <p><b>The lamp substitution does not work if the warning lights have been activated.</b></p>	
<p><b>F Substitution des feux en cas de panne des clignotants de la remorque</b></p> <p>Une panne du clignotant de la remorque (à droite, à gauche ou des deux côtés) est indiquée au conducteur sur l'instrument combiné du véhicule tracteur par l'affichage d'un message de texte sur l'écran, une augmentation de la fréquence de clignotement et/ou par un voyant de contrôle de panne de lampe, qui s'allume.</p> <p><b>En outre, si le clignotant est activé, le feu arrière de la remorque correspondant devient alors un clignotant (► substitution des feux):</b></p> <p>en cas de panne du clignotant, le feu arrière gauche ou droit remplace le clignotant défectueux en s'allumant à la même fréquence que le clignotant!</p> <p><b>La substitution du feu ne fonctionne pas si les feux de détresse sont activés.</b></p>	<p><b>I Sostituzione della luce in caso di anomalia alle frecce del rimorchio</b></p> <p>Il guasto di una freccia del rimorchio (destra, sinistra o entrambi i lati) viene segnalato al conducente sulla plancia portastrumenti della motrice mediante un messaggio di testo sul display, l'aumento della frequenza di lampeggio e/o tramite accensione di una spia di controllo indicante che una lampadina è bruciata.</p> <p><b>Quando si attiva l'indicatore di direzione, inoltre, la relativa luce posteriore del rimorchio diventa freccia (► sostituzione della luce):</b></p> <p>In caso di guasto alla luce della freccia, la luce posteriore sinistra o destra si accende sostituendo nella frequenza del lampeggio la freccia difettosa!</p> <p><b>La sostituzione della luce non funziona se sono attivati i lampeggiatori di emergenza.</b></p>	
<p><b>E Sustitución de lámpara en caso de fallo de los intermitentes del remolque</b></p> <p>El fallo de uno de los intermitentes del remolque (izquierdo, derecho o en ambos lados) se le indicará al conductor en el display de información del instrumento combinado del vehículo tractor en forma de mensaje de texto y/o por medio de la iluminación de una lámpara piloto para el fallo de una lámpara.</p> <p><b>Con el intermitente activado, además, la luz trasera correspondiente del remolque asumirá la función de intermitente (► sustitución de lámpara):</b></p> <p>¡En caso de fallo de un intermitente, la luz trasera izquierda y/o derecha sustituirá el intermitente defectuoso parpadeando en la frecuencia de los intermitentes!</p> <p><b>La sustitución de lámpara no funcionará con los intermitentes de emergencia activados.</b></p>	<p><b>NL Vervanging van lampen bij uitvallen van de knipperlichten van de richtingaanwijzer van de aanhanger</b></p> <p>Het uitvallen van een knipperlicht van de richtingaanwijzer op de aanhanger (rechts, links of aan beide kanten) krijgt de chauffeur op het combi-instrument van het trekvoertuig te zien via een tekstmelding op het display, een verhoging van de knipperfrequentie en/of doordat een controlelamp voor het uitvallen van lampen gaat branden.</p> <p><b>Als de richtingaanwijzer is geactiveerd, wordt de betreffende achterlamp van de aanhanger bovendien een knipperlicht van de richtingaanwijzer (► vervanging van lampen):</b></p> <p>Als het knipperlicht van de richtingaanwijzer uitvalt, vervangt het linker c.q. rechter achterlicht het defecte knipperlicht van de richtingaanwijzer door in de knipperfrequentie te gaan branden!</p> <p><b>Het vervangen van de lampen functioneert niet als het noodknipperlicht geactiveerd is.</b></p>	

ERKLÄRUNG SYMBOLE	SYMBOL EXPLANATION	EXPLICATION DES SIMBOLES	SPIEGAZIONE DEI SIMBOLI	EXPLICACIÓN DE LOS SIMBOLES	VERKLARING SYMBOLEN
(D)	(GB)	(F)	(I)	(E)	(NL)
linke (58-L) bzw. rechte (58-R) Schlussleuchte	left (58-L) respectively right (58-R) tail light	feu arrière gauche (58-L) respectivement droite (58-R)	luce posteriore sinistra (58-L) rispettivamente destra (58-R)	plato trasero izquierdo (58-L) respectivamente derecho (58-R)	Linker (58-L) c.q. rechter (58-R) achterlicht
Bremsleuchte (54) / 3. Bremsleuchte (54)	stop light (54) / high mounted, third stop light (54)	3ème feu de stop (54)	luce d'arresto (54) / 3. luce d'arresto (54)	luz de freno (54) / tercera luz de freno (54)	Remlicht (54) / 3e remlicht (54)
Fahrtrichtungsanzeiger links	turn signal indicator left	feu indicateur de direction gauche	indicatore di direzione sinistra	luz indicadora de dirección de marcha izquierda	Richtingaanwijzer links
Fahrtrichtungsanzeiger rechts	turn signal indicator right	feu indicateur de direction droite	indicatore di direzione destra	luz indicadora de dirección de marcha derecha	Richtingaanwijzer rechts
Nebelschlussleuchte(n)	rear fog light(s)	feu (x) arrière (s) de brouillard	fendinebbia	luz (-ces) trasera (s) antineblia (s)	Mistachterlicht(en)
Rückfahrleuchte(n)	reversing light(s)	feu (x) de marche arrière	luce (i) retromarcia	luz (-ces) de marcha atrás	Achteruitrijlicht(en)
Dauerstrom / Steckdose 13P Kammer 9	Permanent power supply / 13pin socket, chamber 9	courant continué / prise de courant à 13 pôles, compartiment 9	alimentazione continua / presa 13 poli, camera 9	positivo continuo / caja de anclure a 13 polos, cámara 9	Continuustroom / stekkerdoos 13P kamer 9
Ladelleitung / Steckdose 13P Kammer 10	charging wire for trailer battery / 13pin socket, chamber 10	cable de charge / prise de courant à 13 pôles, compartiment 10	cavo di carica / presa 13 poli, camera 10	cable de carga / caja de anclure a 13 polos, cámara 10	Laaddraad / stekkerdoos 13P kamer 10
Anhänger / Anhängerkennung	trailer / trailer recognition	remorque / détection de la fonction "remorque"	rimorchio / riconoscimento rimorchio	remolque / detección del remolque	Aanhanger / aanhangeridentificatie
Dauerstrom / permanente Stromversorgung	Permanent current power supply	courant continué / alimentation électrique permanente	corrente / alimentazione continua	positivo continuo / alimentación de corriente permanente	Continuustroom / permanente stroomvoorziening
Masse (31)	Ground or Earth (31)	masse (31)	massa (31)	masa (31)	Massa (31)
Batteriepolklemme Anschluss Minus	ground connection battery terminal lug	borne "moins" de la batterie	connessione negativa della batteria	conexión negativa de batería	Accupoolklem aansluiting min
Batteriepolklemme Anschluss Plus	positive connection battery terminal lug	borne "plus" de la batterie	connessione positiva della batteria	conexión positiva de batería	Accupoolklem aansluiting plus
Sicherung / Sicherungsstärke 20 Ampère	fuse / fuse capacity 20 Ampère	ampérage 20 ampères	fusibile / fusibile con capacità 20 Ampère	fusible / amperaje 20 amperes	Zekering / zekeringsterkte 20 Ampère
Zigarettenanzünder / Zubehör-Steckdose	cigarette lighter / accessory socket	allume-cigare / prise d'accessoires	accendisigari / presa accessori	encendido de cigarrillos / caja de accesorios	Sigarettenaansteker / accessoirestekkerdoos
Lautsprecher / Warnsummer	loudspeaker / buzzer	haut-parleur / vibreur	autoparlante / cicalino	altavoz / señal acústica de advertencia	Luidspreker / waarschuwingszoemer
Einparkhilfe	park distance control	assistance au parking	sensori di parcheggio	ayuda para aparcar	Inparkeerhulp
Schalter / Funktionsursprung	switch / source of function	interrupteur / origine de fonction	interruttore / origine funzione	interruptor / origen de función	Schakelaar / functieoorsprong
verbinden	Connect together	raccorder	connessione	conectar	Koppelen
trennen	disconnect	séparer	sconnessione	separar	Ontkoppelen
beachten / siehe weitere Informationen	Look at / see further information	considérer / voir informations ultérieures	considerare / vedere ulteriori informazioni	considerar / véase las informaciones	Let op / bekijk verdere informatie
beachte auserwählten Bereich	look carefully at selected area	faire attention à la zone sélectionnée	considerare area selezionata	considerar el área seleccionada	Let op gekozen bereik
vorhanden / belegt / i.O.	Present / Occupied / OK	disponible / occupé / OK	presente / occupato / OK	presente / ocupado / OK	Aanwezig / bezet / i.o.
nicht vorhanden / nicht belegt / nicht i.O.	Not present / Not occupied / not OK	pas disponible / pas occupé / pas OK	non presente / non occupato / non OK	non presente / non ocupado / non OK	Niet aanwezig / niet bezet / niet i.o.
links	left	gauche	sinistra	izquierdo	Links
rechts	right	droite	destra	derecho	Rechts
Akustische Signalisierung	acoustic indication	signalisation acoustique	segnalazione acustica	señalización acústica	Akoestische signalering
Achtung / wichtiger Hinweis	attention / important advice	attention / indication importante	attenzione / indicazione importante	atención / indicación importante	Attentie / belangrijke instructie